

Relay <b>3</b>	Lane <b>21</b>	<b>Arto LAHTINEN</b>		
JSM	VS-VA	APY		
10.03.2018	Joukkue SM	Kankaanpään Ampumaurheilijat		
Series 1		1: 10.0 → 2: 8.4 ↗ 3: 9.7 ← 4: 9.4 ↗ 5: 8.9 ↑ 6: 8.4 ↑ 7: 6.3 ↗ 8: 10.6x ↓ 9: 9.1 ↑ 10: 9.7 ↓ Series 86 86	Series 2 	1: 9.4 ↗ 2: 9.1 ↗ 3: 8.9 ↗ 4: 9.7 ↑ 5: 10.0 ↑ 6: 8.9 ↘ 7: 8.3 ↓ 8: 9.4 ↗ 9: 9.3 ↘ 10: 9.3 ↗ Series 88 174
Series 3		1: 6.6 ↗ 2: 8.2 ↗ 3: 10.2 → 4: 10.3 ← 5: 8.7 ↗ 6: 9.7 ← 7: 9.4 ← 8: 10.8x → 9: 9.4 ↓ 10: 10.0 → Series 89 263	Series 4 	1: 9.4 ↗ 2: 9.1 ↘ 3: 7.0 ↘ 4: 9.6 → 5: 9.4 ← 6: 10.0 → 7: 10.1 ↘ 8: 9.2 ↘ 9: 10.0 ↑ 10: 7.6 ↗ Series 89 352
Series 5		1: 9.0 ← 2: 10.3 ↓ 3: 8.6 ↗ 4: 9.8 ← 5: 8.0 ↓ 6: 9.6 ↘ 7: 6.9 ← 8: 9.6 ↗ 9: 7.8 ↓ 10: 10.2 ↓ Series 85 437	Series 6 	1: 10.3 ↘ 2: 9.2 ↗ 3: 9.7 ↓ 4: 8.7 ↓ 5: 10.8x ↗ 6: 8.0 ↘ 7: 9.8 → 8: 9.6 ← 9: 10.6x ↗ 10: 8.0 → Series 90 527

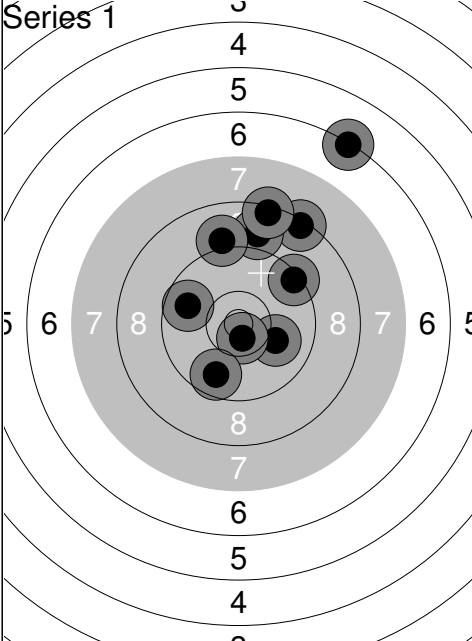

1:	7.9	→
2:	9.8	↓
3:	10.6x	↑
4:	10.6x	↓
5:	9.1	↓
6:	10.1	→
7:	9.9	←
8:	7.4	↓
9:	10.2	↓
10:	9.4	↑
<b>Series</b>	<b>90</b>	
	<b>90</b>	

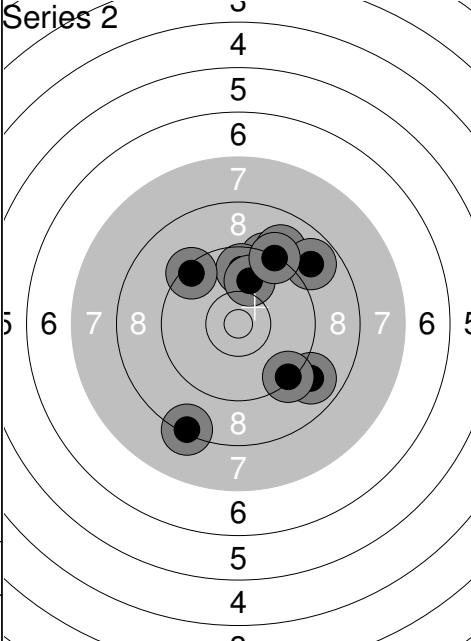
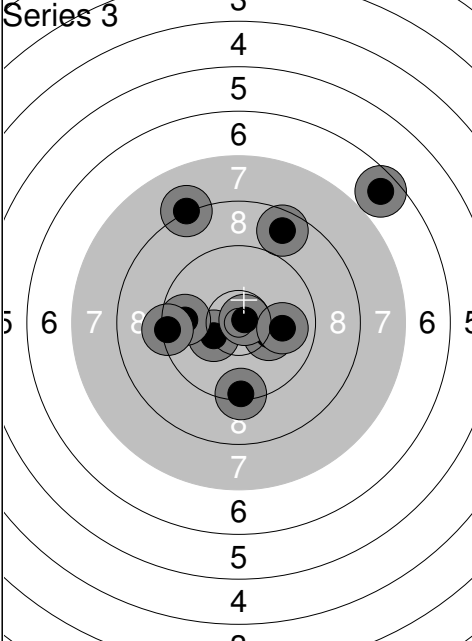
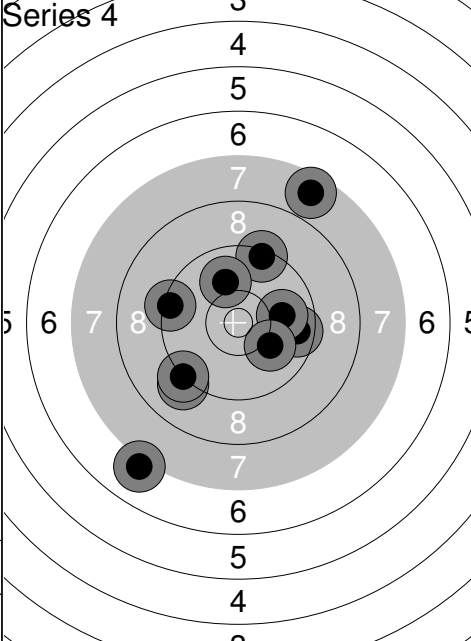
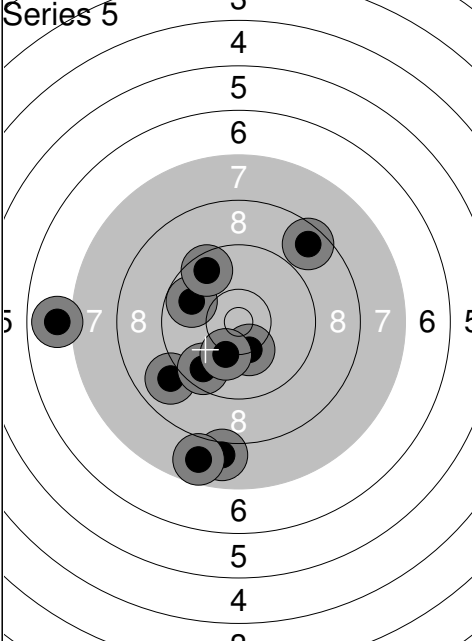
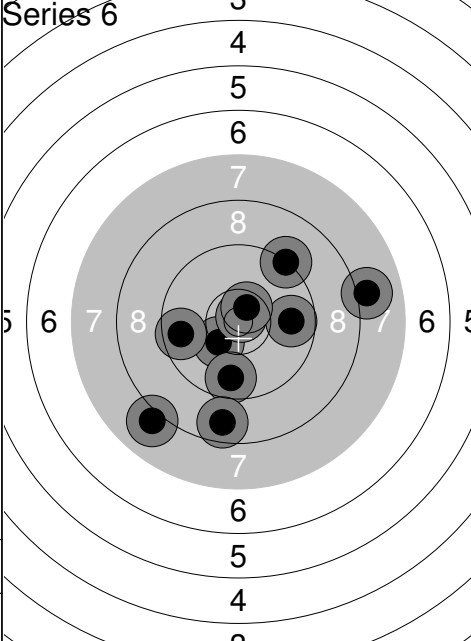
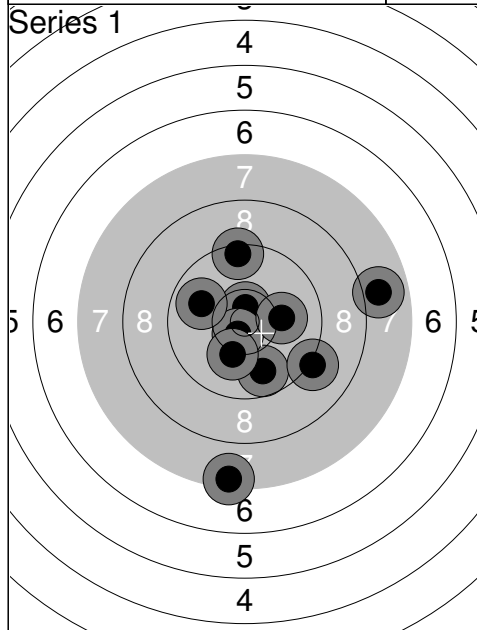
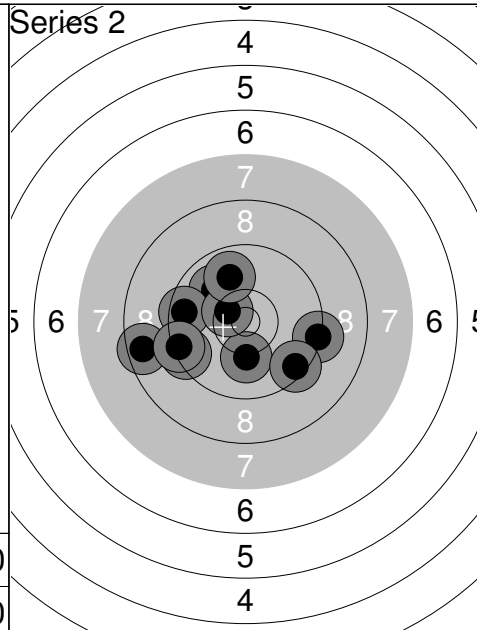

1:	10.2	↓
2:	10.0	↗
3:	9.3	→
4:	9.4	↓
5:	8.6	←
6:	9.6	←
7:	10.5x	↖
8:	9.4	←
9:	9.9	↑
10:	9.4	←
<b>Series</b>	<b>92</b>	
	<b>182</b>	

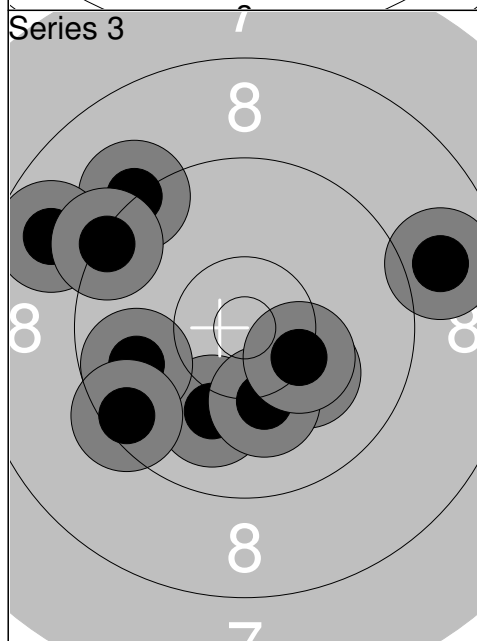

1:	10.2	↓
2:	8.9	→
3:	9.2	↗
4:	10.0	↓
5:	10.2	↓
6:	8.8	←
7:	9.3	←
8:	9.8	←
9:	10.3	→
10:	9.5	←
<b>Series</b>	<b>92</b>	
	<b>274</b>	

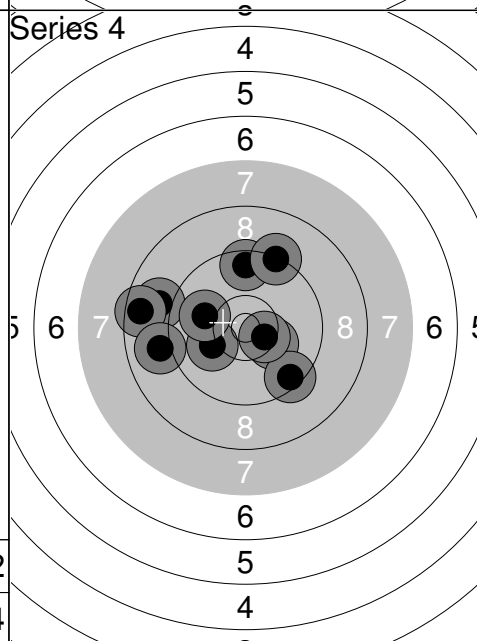

1:	8.9	←
2:	9.5	↑
3:	10.2	↓
4:	9.5	↓
5:	10.1	←
6:	10.0	←
7:	8.6	←
8:	9.3	↑
9:	10.5x	→
10:	9.0	←
<b>Series</b>	<b>92</b>	
	<b>366</b>	

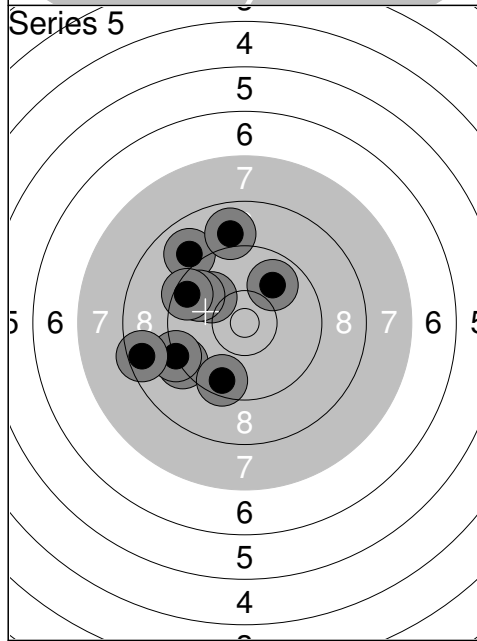

1:	9.3	←
2:	9.9	↗
3:	9.2	←
4:	9.0	↗
5:	8.5	←
6:	10.0	↖
7:	9.6	↓
8:	9.8	←
9:	9.5	←
10:	8.9	↑
<b>Series</b>	<b>89</b>	
	<b>455</b>	

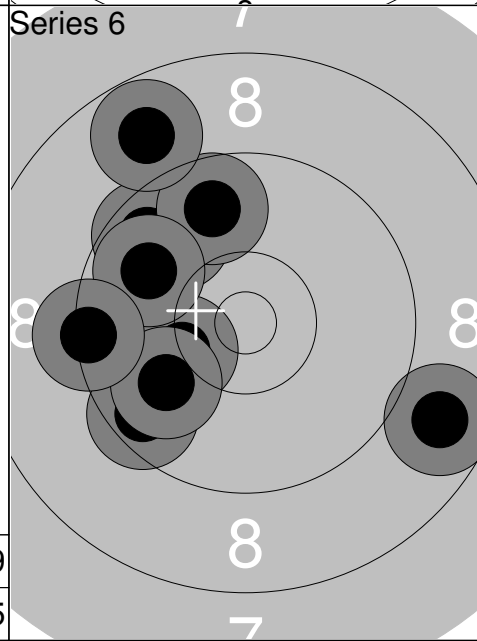

1:	9.6	↖
2:	9.8	↗
3:	9.6	↗
4:	9.7	↑
5:	10.2	←
6:	9.8	↖
7:	9.9	↖
8:	9.4	←
9:	8.8	→
10:	8.8	↗
<b>Series</b>	<b>89</b>	
	<b>544</b>	

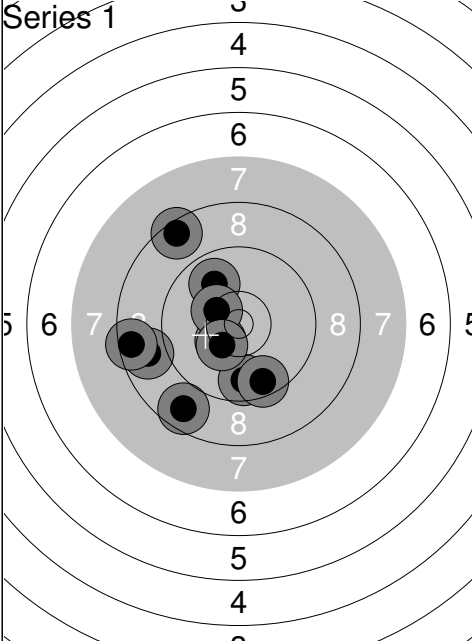
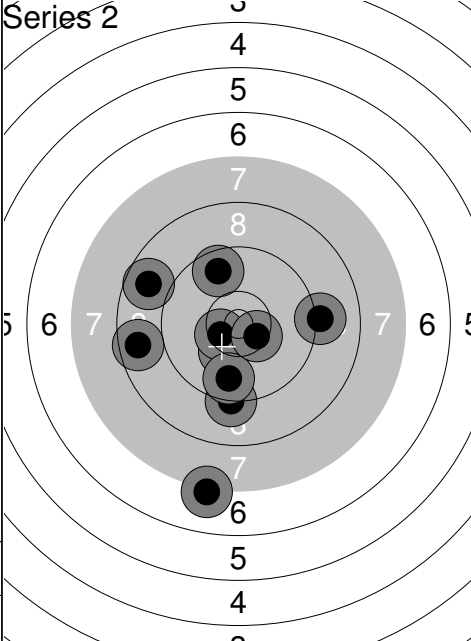
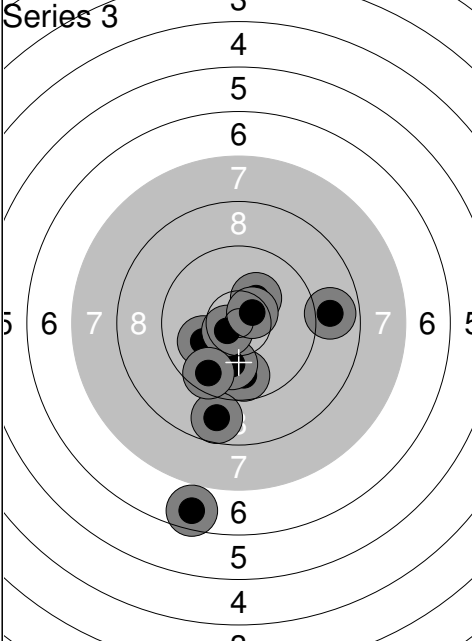
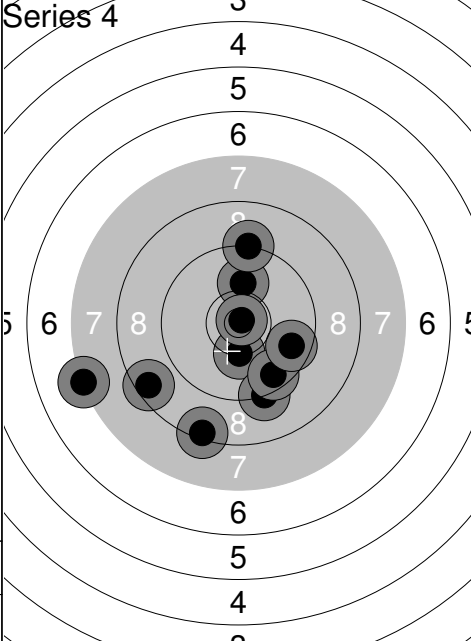
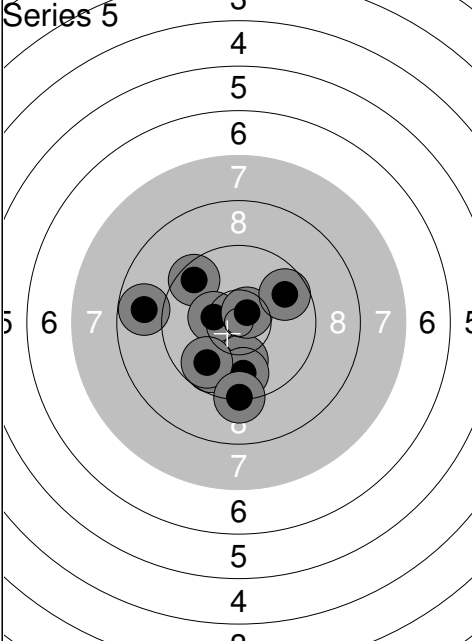
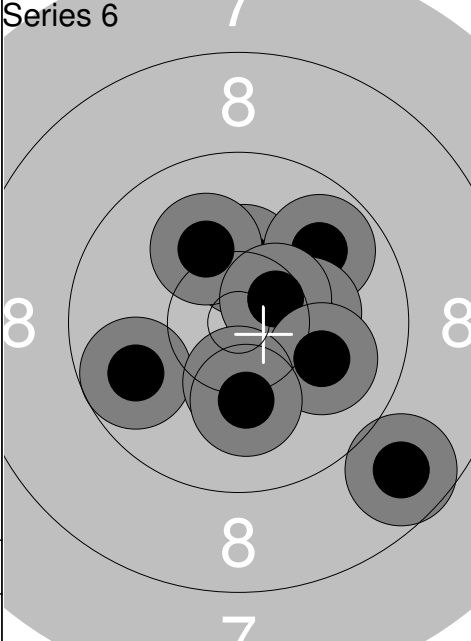
Relay	Lane	Niklas MYLLYMÄKI	
3	23	NoSA	APY
10.03.2018	Joukkue SM	Kankaanpään Ampumaurheilijat	
Series 1		1: 8.5 ↗ 2: 8.8 ← 3: 9.9 ↗ 4: 8.5 ← 5: 9.7 ↓ 6: 10.4x ↙ 7: 8.7 ↘ 8: 10.4x ↙ 9: 10.3 ↘ 10: 9.5 ↘ Series 89 89	Series 2  1: 10.3 ↘ 2: 9.1 → 3: 9.7 ↗ 4: 8.7 ← 5: 8.6 ← 6: 9.2 ↓ 7: 10.5x ↙ 8: 9.7 ↓ 9: 7.1 ↓ 10: 10.5x ↘ Series 89 178
Series 3		1: 8.9 → 2: 9.8 ↓ 3: 10.0 ↓ 4: 8.8 ↓ 5: 10.3 ↗ 6: 10.1 ← 7: 10.6x ↙ 8: 6.6 ↓ 9: 10.6x ↗ 10: 9.6 ↘ Series 90 268	Series 4  1: 7.3 ← 2: 8.5 ← 3: 10.1 ↑ 4: 10.3 ↓ 5: 9.2 ↓ 6: 8.4 ↓ 7: 10.8x ↗ 8: 9.2 ↑ 9: 9.6 ↘ 10: 9.7 → Series 89 357
Series 5		1: 9.6 ↘ 2: 10.1 ↓ 3: 10.4x ← 4: 10.7x ↗ 5: 9.8 ↓ 6: 9.7 ↗ 7: 9.8 ↓ 8: 9.8 ↓ 9: 8.8 ← 10: 9.3 ↓ Series 92 449	Series 6  1: 10.3 ↑ 2: 10.1 ↗ 3: 9.9 ↗ 4: 10.3 → 5: 10.5x ↗ 6: 9.8 ← 7: 10.0 → 8: 8.7 ↘ 9: 10.3 ↓ 10: 10.2 ↓ Series 96 545



Relay	Lane	Henri HYNNINEN	
3	25		
JSM	SA	APY	
10.03.2018	Joukkue SM	Kankaanpään Ampumaurheilijat	
Series 1		1: 10.8x ↑ 2: 9.5 ← 3: 6.5 → 4: 8.6 ↙ 5: 10.6x ↑ 6: 10.7x ← 7: 9.5 ← 8: 10.1 ↙ 9: 8.2 ↑ 10: 9.9 →	Series 89
Series 2		1: 9.4 ↗ 2: 9.6 ↖ 3: 9.8 ↑ 4: 9.2 → 5: 10.1 ↑ 6: 9.4 → 7: 10.4x ← 8: 9.6 ← 9: 9.5 ↘ 10: 7.7 ←	Series 90
		179	
Series 3		1: 10.6x ↘ 2: 10.0 ↑ 3: 10.2 ↓ 4: 9.0 ↑ 5: 9.6 ↓ 6: 9.8 ↓ 7: 9.4 ↓ 8: 9.5 ↙ 9: 9.0 → 10: 8.4 ↖	Series 92
Series 4		1: 10.1 → 2: 8.7 ↗ 3: 9.5 → 4: 10.2 ↖ 5: 9.0 → 6: 7.6 ↑ 7: 8.5 ← 8: 9.3 ↗ 9: 7.4 ↑ 10: 9.9 ←	Series 86
		357	
Series 5		1: 7.6 → 2: 10.3 ↗ 3: 9.4 ↖ 4: 9.5 ← 5: 9.6 ↑ 6: 9.4 ↑ 7: 10.4 → 8: 10.6x ↖ 9: 10.0 ↗ 10: 9.4 ↖	Series 92
Series 6		1: 10.9x ↗ 2: 9.2 ↓ 3: 9.3 → 4: 8.8 ↑ 5: 10.5x ↑ 6: 9.7 ↑ 7: 10.5x ← 8: 9.8 ↑ 9: 10.4x ← 10: 9.6 ←	Series 93
		542	
		449	

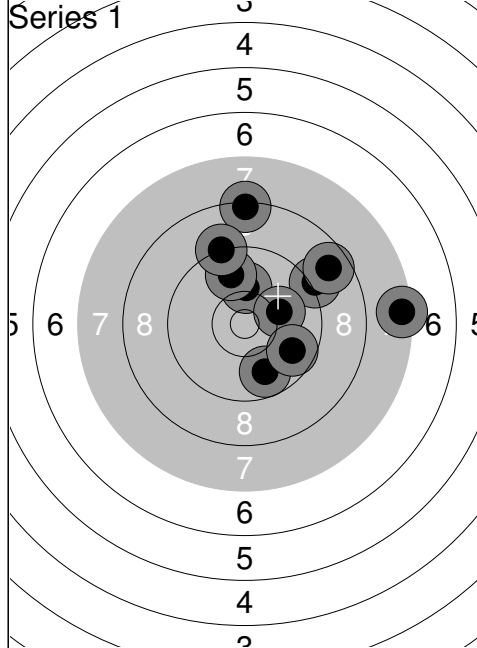

1:	8.3	↑
2:	9.8	↓
3:	7.4	→
4:	9.1	↗
5:	10.1	↑
6:	10.1	→
7:	8.7	↗
8:	9.8	↑
9:	9.7	↘
10:	9.2	↑
<b>Series</b>	<b>88</b>	
	<b>88</b>	

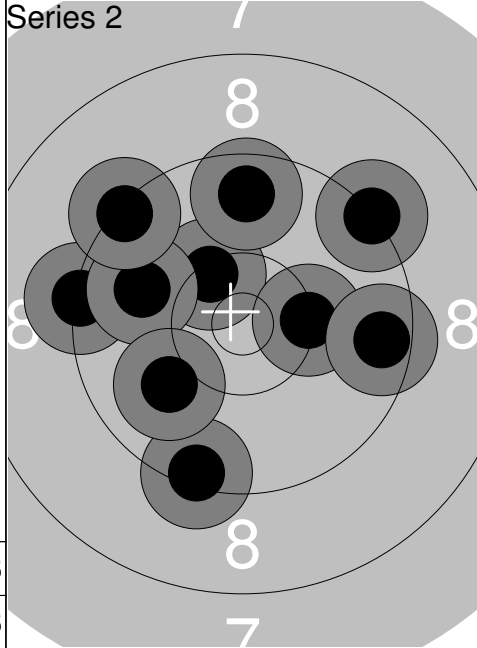

1:	9.3	←
2:	10.3	↗
3:	9.9	←
4:	9.4	↓
5:	10.3	→
6:	9.2	↗
7:	9.6	↑
8:	9.5	→
9:	10.0	↙
10:	9.3	↖
<b>Series</b>	<b>93</b>	
	<b>181</b>	

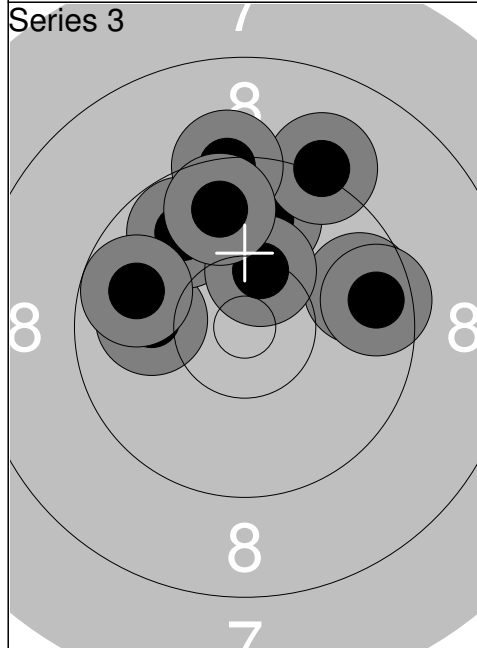

1:	10.0	←
2:	9.8	↑
3:	9.7	→
4:	9.2	↗
5:	9.8	↖
6:	10.3	↑
7:	9.6	→
8:	9.8	←
9:	9.3	↑
10:	9.7	↑
<b>Series</b>	<b>92</b>	
	<b>273</b>	

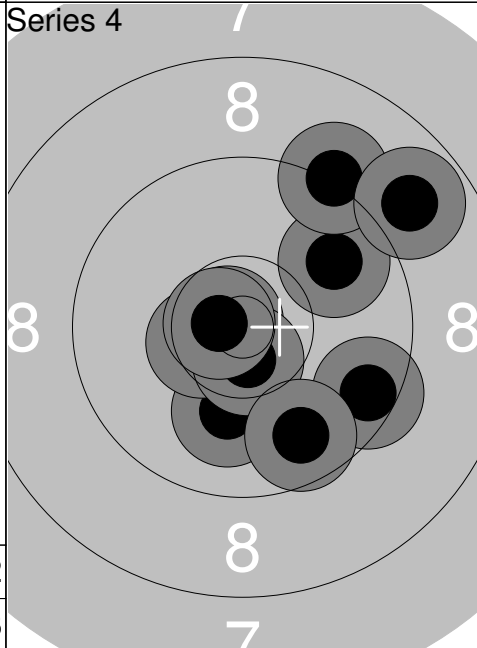

1:	10.8x	↙
2:	9.8	↗
3:	9.5	↘
4:	10.1	↓
5:	10.5x	↙
6:	10.6x	↓
7:	9.7	↓
8:	10.7x	↙
9:	9.2	↗
10:	8.8	↗
<b>Series</b>	<b>94</b>	
	<b>367</b>	

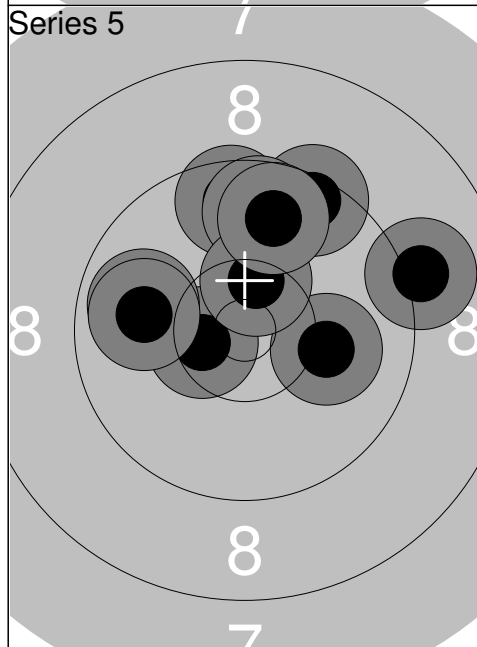

1:	10.5x	↙
2:	9.1	→
3:	9.9	←
4:	9.5	↗
5:	9.6	↑
6:	9.7	↑
7:	10.1	→
8:	10.4x	↑
9:	9.8	↑
10:	9.9	←
<b>Series</b>	<b>93</b>	
	<b>460</b>	

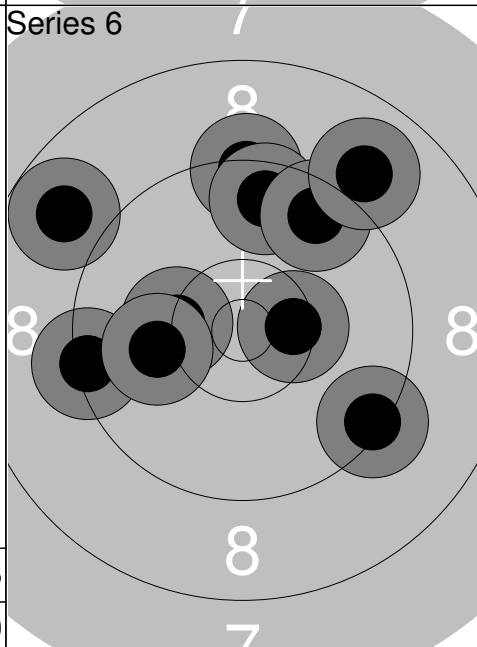

1:	8.8	↖
2:	9.3	↑
3:	9.3	←
4:	10.3	←
5:	9.6	↑
6:	9.6	↗
7:	10.1	←
8:	9.3	↘
9:	8.9	↗
10:	10.4x	→
<b>Series</b>	<b>91</b>	
	<b>551</b>	

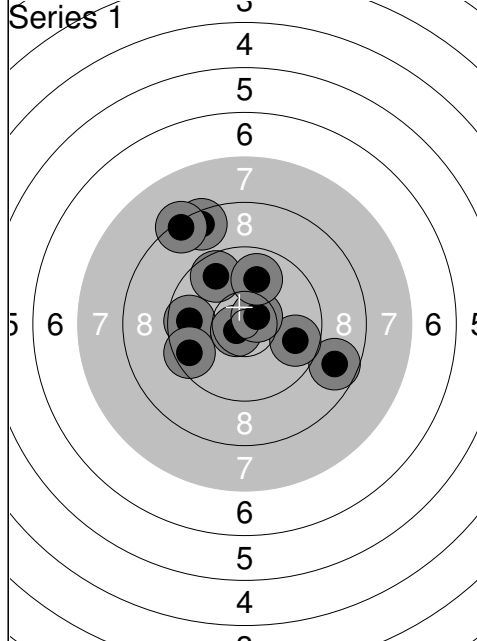

1:	9.7	←
2:	8.8	→
3:	8.5	↗
4:	9.5	←
5:	9.7	↗
6:	10.7x	↙
7:	8.4	↗
8:	9.8	→
9:	10.6x	↗
10:	9.9	↑
<b>Series</b>	<b>89</b>	
	<b>89</b>	

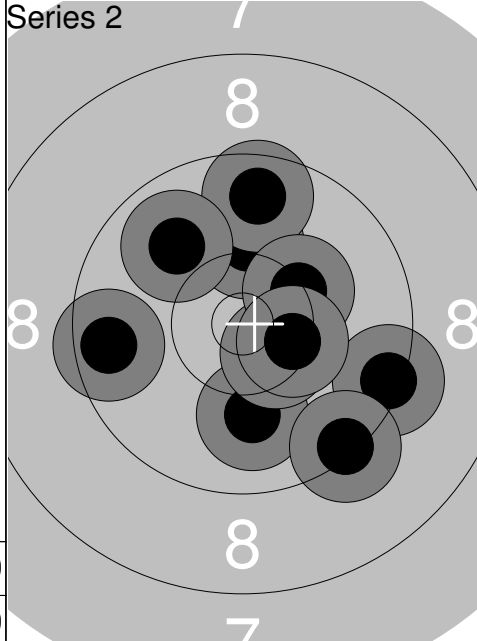

1:	9.4	→
2:	10.0	↓
3:	10.1	↑
4:	9.6	←
5:	9.3	↘
6:	10.5x	↘
7:	9.6	↑
8:	10.3	↗
9:	10.4x	→
10:	9.9	↖
<b>Series</b>	<b>95</b>	
	<b>184</b>	

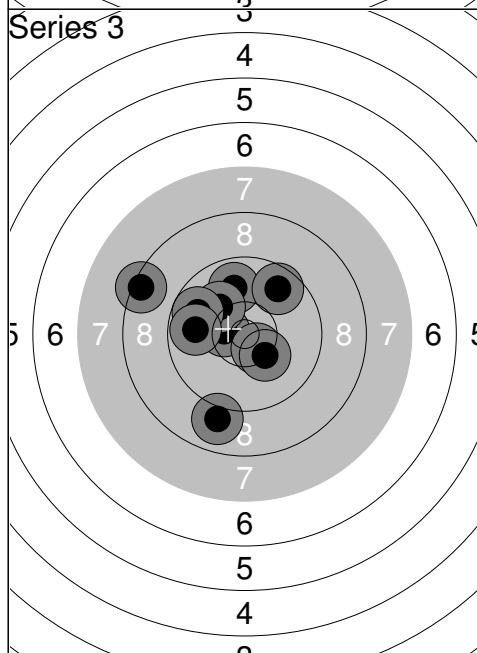

1:	9.9	↑
2:	10.5x	←
3:	9.7	↗
4:	9.0	↓
5:	10.5x	↘
6:	10.1	↗
7:	9.8	←
8:	9.8	←
9:	8.4	←
10:	10.3	↘
<b>Series</b>	<b>93</b>	
	<b>277</b>	

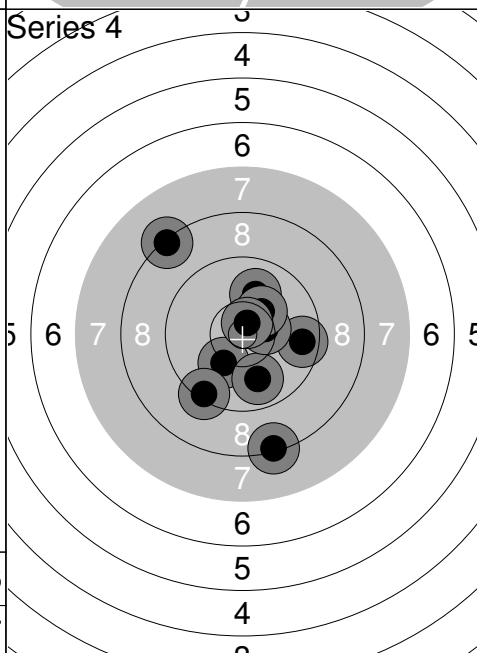

1:	10.2	↙
2:	9.6	→
3:	10.0	↑
4:	9.9	↓
5:	8.3	↓
6:	8.3	↖
7:	9.4	↓
8:	10.4x	→
9:	10.3	↗
10:	10.7x	↗
<b>Series</b>	<b>93</b>	
	<b>370</b>	

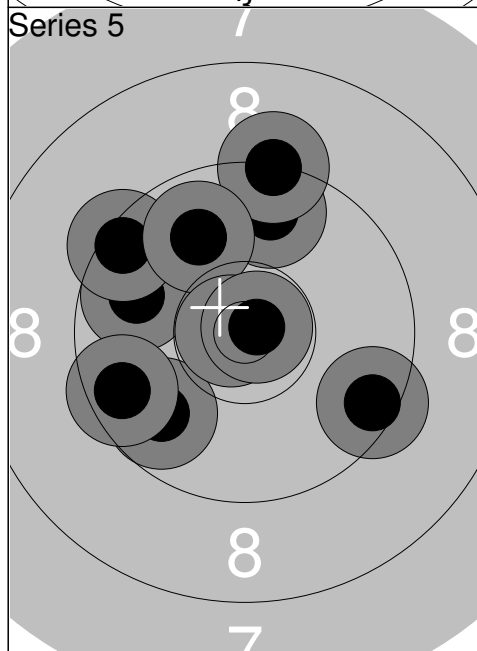

1:	9.8	↙
2:	9.5	↘
3:	9.8	←
4:	9.7	↑
5:	9.3	↑
6:	9.4	↖
7:	9.9	↗
8:	10.8x	←
9:	10.8x	→
10:	9.6	←
<b>Series</b>	<b>92</b>	
	<b>462</b>	

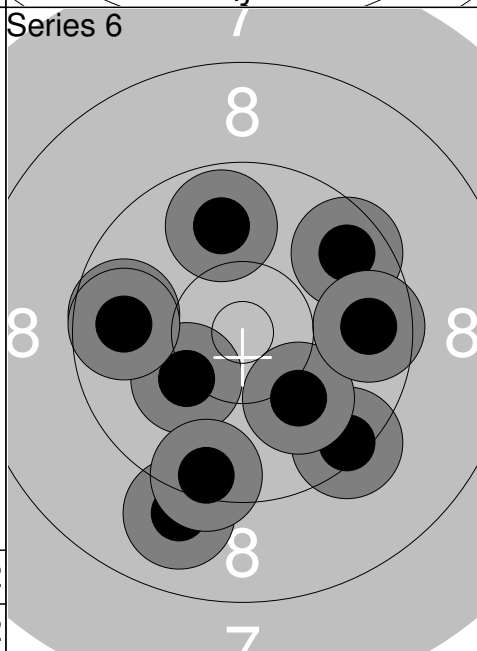

1:	10.2	↙
2:	9.0	↓
3:	9.4	↘
4:	9.7	←
5:	9.5	↓
6:	9.6	↗
7:	9.8	↑
8:	10.1	↘
9:	9.7	←
10:	9.7	→
<b>Series</b>	<b>92</b>	
	<b>554</b>	

Relay	Lane	Jussi NYLUND			
3	28				
JSM	HIAS	APY			
10.03.2018	Joukkue SM	Kankaanpään Ampumaurheilijat			
Series 1		1: 10.6x ↗ 2: 10.0 ↖ 3: 10.0 ↓ 4: 8.6 ↓ 5: 10.6x ← 6: 10.5x ↓ 7: 7.9 ← 8: 7.5 ← 9: 7.3 ↗ 10: 8.9 ↓	Series 2		1: 10.7x ↗ 2: 9.7 ← 3: 9.8 ↓ 4: 9.0 ← 5: 8.4 ↓ 6: 8.2 ↓ 7: 8.9 ↓ 8: 10.0 → 9: 9.1 ↓ 10: 8.5 ↓
		Series	87	Series	88
			87		175
Series 3		1: 8.6 ← 2: 10.6x ↗ 3: 9.1 ← 4: 10.6x ↓ 5: 6.9 ← 6: 10.1 ↓ 7: 8.6 ↑ 8: 10.7x ↘ 9: 8.6 ↓ 10: 10.6x ↑	Series 4		1: 10.2 ← 2: 9.8 ← 3: 9.8 ↑ 4: 9.4 ↓ 5: 9.9 ← 6: 8.9 ← 7: 8.5 ↓ 8: 8.9 ↑ 9: 9.8 → 10: 7.5 ↓
		Series	89	Series	86
			264		350
Series 5		1: 7.8 ← 2: 9.4 ← 3: 7.8 ← 4: 8.5 ↓ 5: 8.4 ← 6: 10.8x → 7: 9.0 ↓ 8: 9.0 ← 9: 9.9 ← 10: 9.4 ↓	Series 6		1: 7.9 ↗ 2: 8.7 ↓ 3: 8.0 ← 4: 10.3 ↗ 5: 10.0 ↓ 6: 8.9 ← 7: 9.6 ↗ 8: 9.4 ← 9: 7.2 ← 10: 8.6 ←
		Series	85	Series	84
			435		519



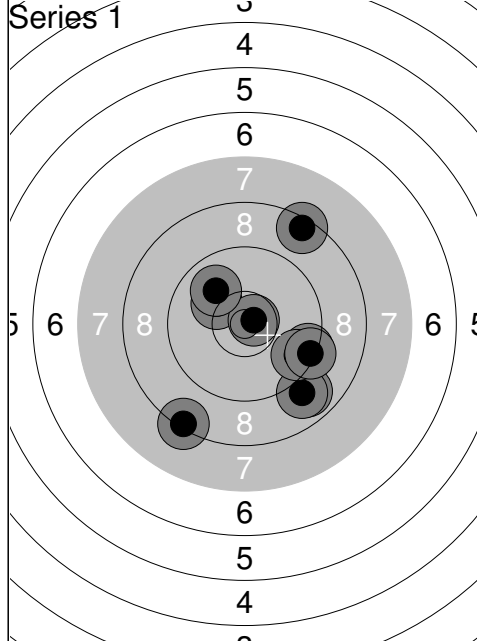

1:	10.2	↖
2:	8.9	↘
3:	10.7x	↗
4:	8.9	↘
5:	8.3	↘
6:	8.5	↗
7:	9.4	↗
8:	9.6	↘
9:	10.0	↗
10:	9.3	↗
<b>Series</b>	<b>89</b>	
	<b>89</b>	

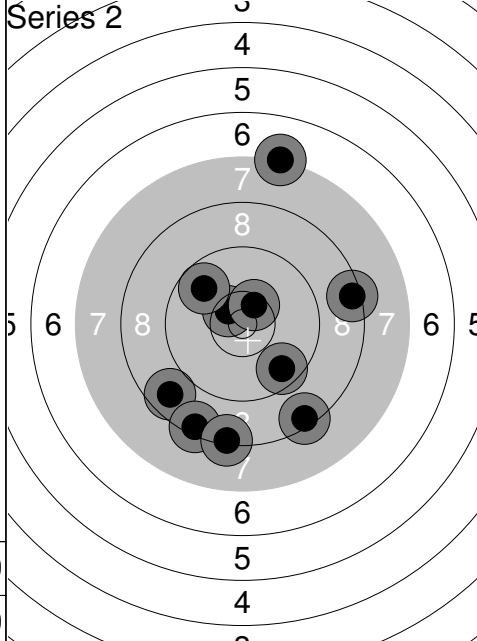

1:	10.5x	↖
2:	9.8	↖
3:	8.7	↘
4:	8.4	↘
5:	8.4	→
6:	8.3	↓
7:	7.2	↑
8:	10.4x	↗
9:	9.6	↘
10:	8.4	↘
<b>Series</b>	<b>85</b>	
	<b>174</b>	

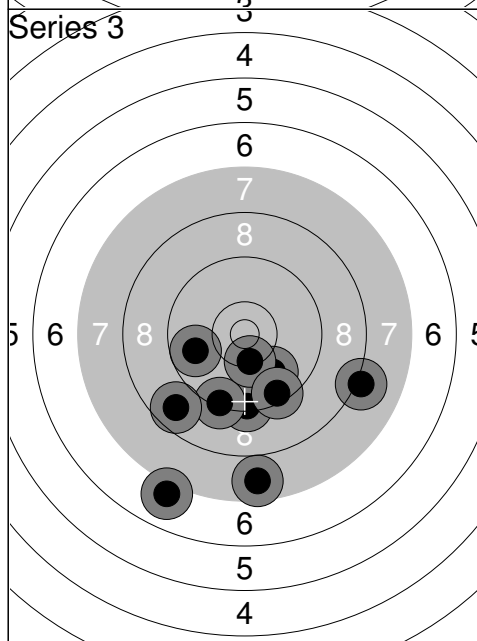

1:	7.7	↓
2:	9.3	↓
3:	9.8	←
4:	9.9	↘
5:	9.3	↘
6:	8.7	↘
7:	8.1	↗
8:	10.3	↓
9:	9.4	↘
10:	7.0	↓
<b>Series</b>	<b>85</b>	
	<b>259</b>	

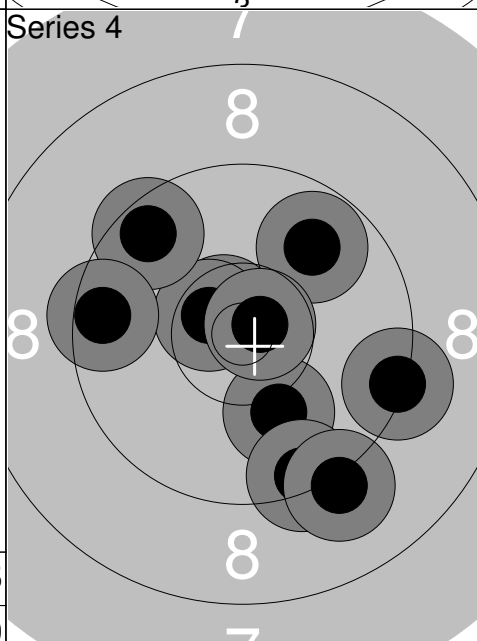

1:	10.6x	↖
2:	10.1	↘
3:	9.4	↘
4:	10.6x	↖
5:	9.1	↘
6:	9.8	↗
7:	9.6	↗
8:	9.3	→
9:	9.5	←
10:	10.7x	↗
<b>Series</b>	<b>94</b>	
	<b>353</b>	

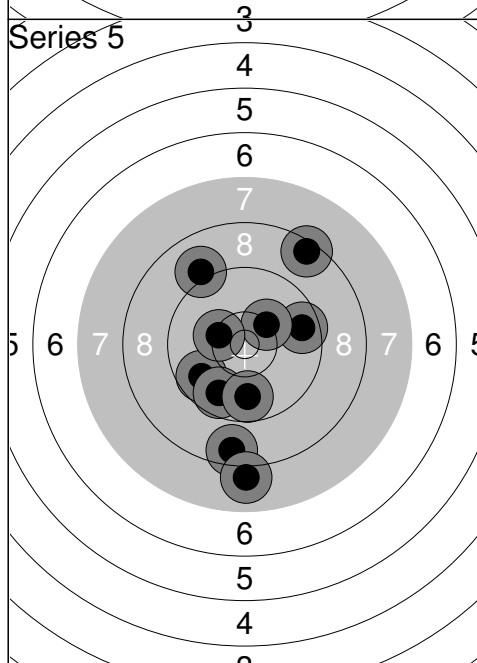

1:	9.8	←
2:	9.7	↘
3:	9.1	↗
4:	9.6	→
5:	10.3	↗
6:	8.6	↘
7:	8.0	↓
8:	9.8	↓
9:	8.5	↗
10:	10.3	←
<b>Series</b>	<b>89</b>	
	<b>442</b>	

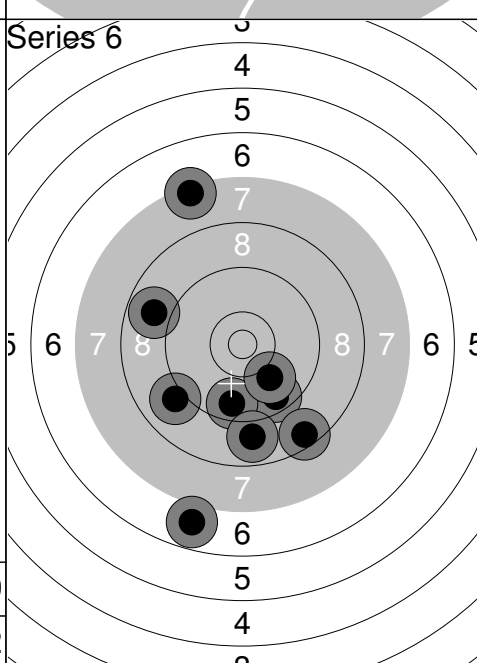

1:	8.8	←
2:	9.5	↓
3:	6.8	↘
4:	9.6	↘
5:	9.0	↖
6:	9.6	↘
7:	8.5	↘
8:	8.9	↓
9:	10.0	↘
10:	7.4	↑
<b>Series</b>	<b>83</b>	
	<b>525</b>	

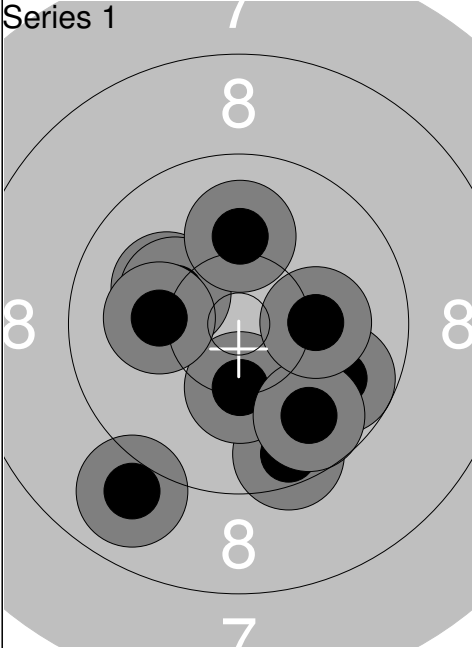
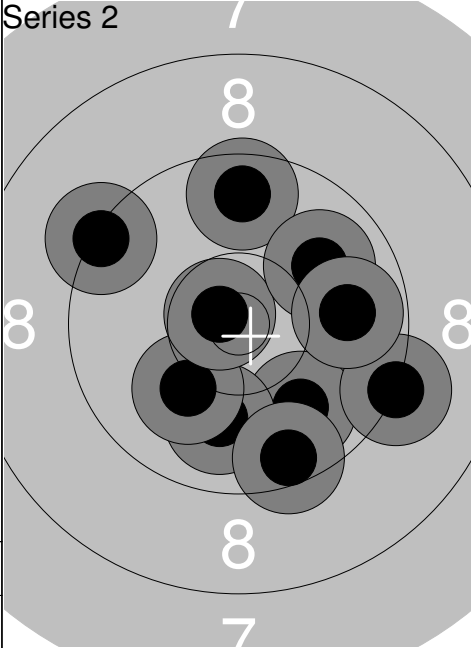
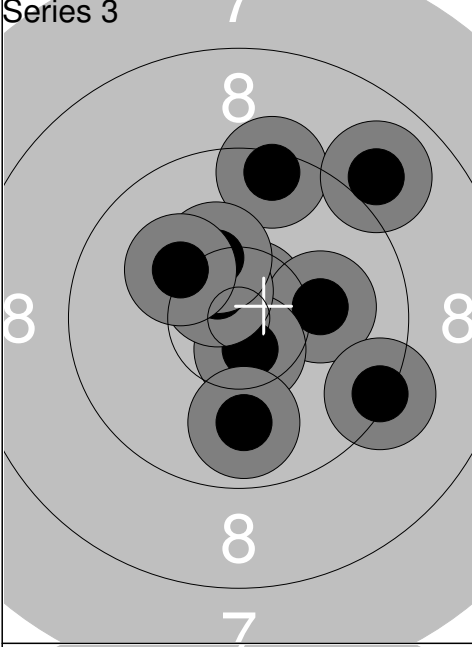
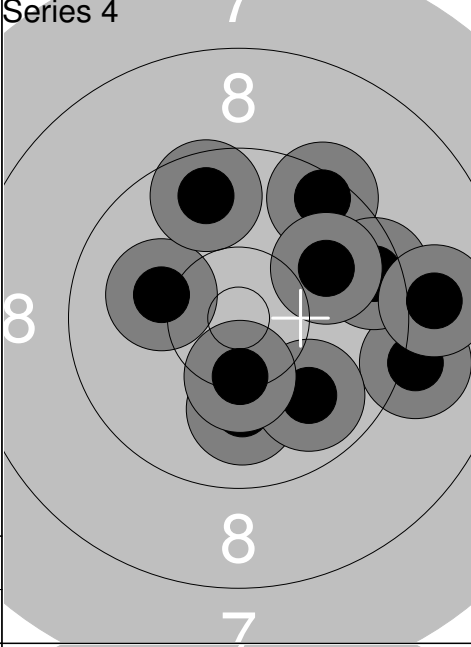
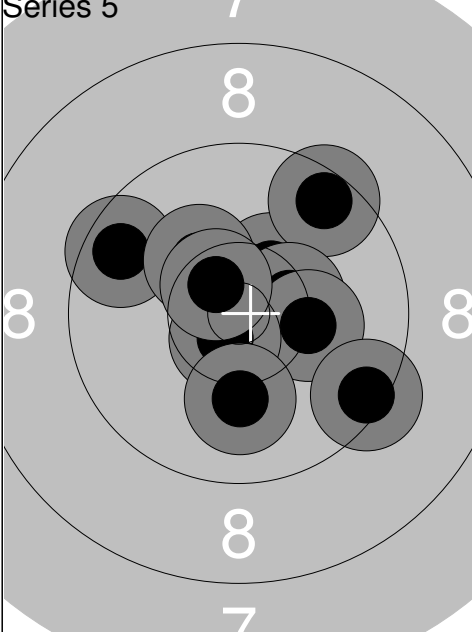
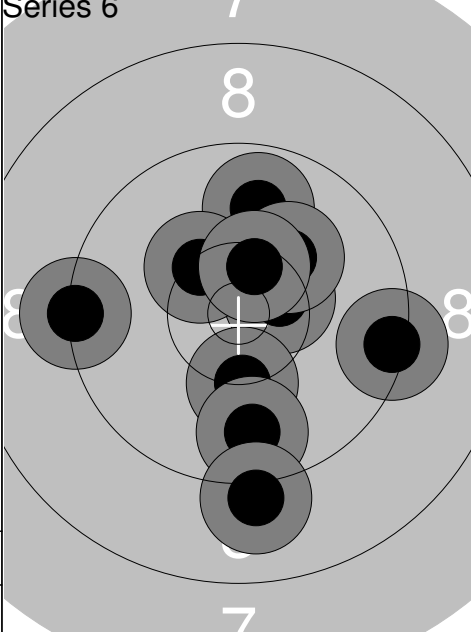
Relay	Lane	Konsta KIVI		
3	30	JSM	TSA	APY
10.03.2018	Joukkue SM	Kankaanpään Ampumaurheilijat		
Series 1		1: 9.5 ↘ 2: 10.1 ↖ 3: 10.3 ↓ 4: 10.2 ↖ 5: 9.8 ↘ 6: 8.9 ↘ 7: 9.8 ↘ 8: 10.1 ← 9: 10.2 → 10: 10.1 ↑	Series 95	Series 95
Series 2		1: 9.9 ↘ 2: 9.3 ↖ 3: 10.0 ↓ 4: 9.6 ↑ 5: 10.1 ↘ 6: 9.2 → 7: 10.7x ↖ 8: 9.5 ↓ 9: 9.9 ↗ 10: 9.8 →	Series 93	Series 93
		95		188
Series 3		1: 10.7x ↗ 2: 9.4 ↑ 3: 10.1 → 4: 9.3 ↘ 5: 10.6x ↓ 6: 10.6x ↖ 7: 9.9 ↓ 8: 9.0 ↗ 9: 10.3 ↑ 10: 10.2 ↖	Series 96	Series 93
Series 4		1: 10.0 ↓ 2: 9.1 → 3: 9.5 ↗ 4: 9.5 → 5: 9.9 ↘ 6: 10.4x ↓ 7: 10.1 ← 8: 9.0 → 9: 9.7 ↑ 10: 9.9 ↗	Series 96	Series 93
		284		377
Series 5		1: 9.6 ↖ 2: 10.4x ↗ 3: 9.5 ↗ 4: 10.4x → 5: 10.2 → 6: 10.7x ↘ 7: 10.1 ↓ 8: 10.3 ↗ 9: 10.6x ↖ 10: 9.4 ↘	Series 97	Series 95
Series 6		1: 9.9 ↑ 2: 10.5x → 3: 10.2 ↗ 4: 9.3 ← 5: 10.2 ↓ 6: 10.3 ↖ 7: 9.7 ↓ 8: 9.1 ↓ 9: 9.4 → 10: 10.4x ↑	Series 97	Series 95
		474		569