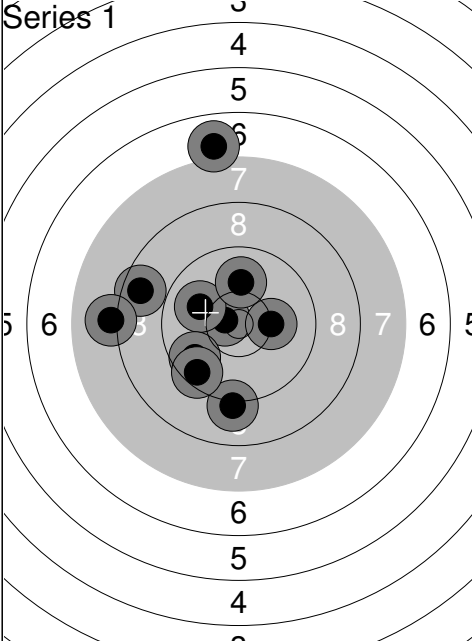
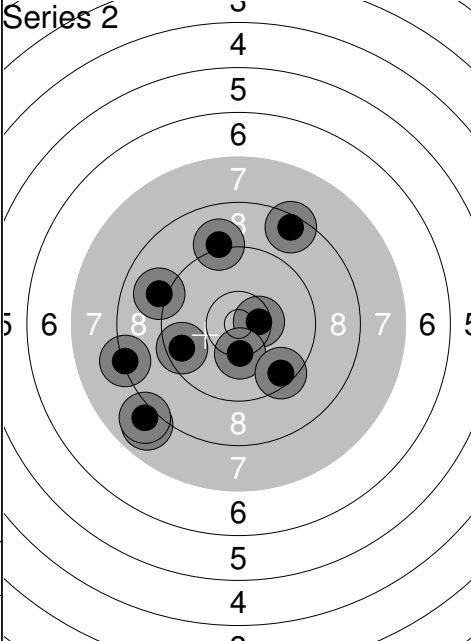
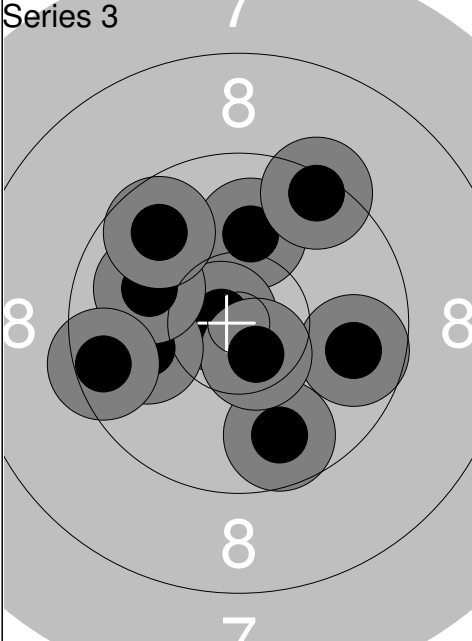
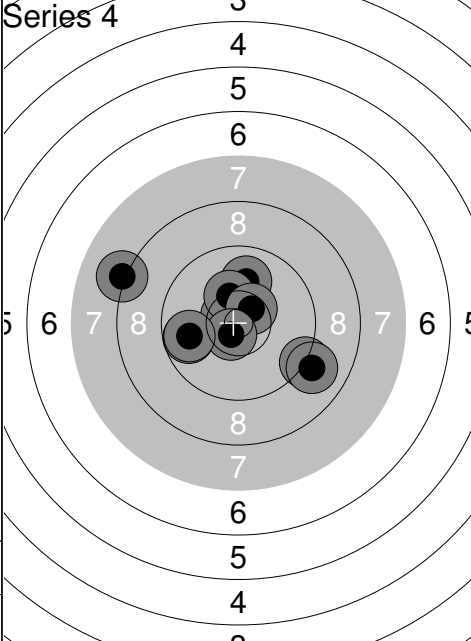
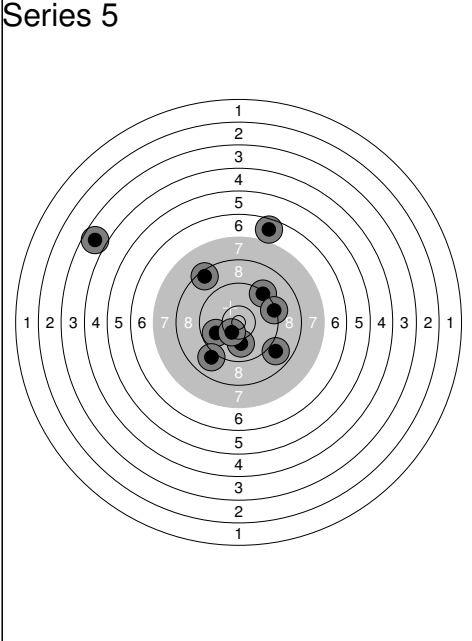
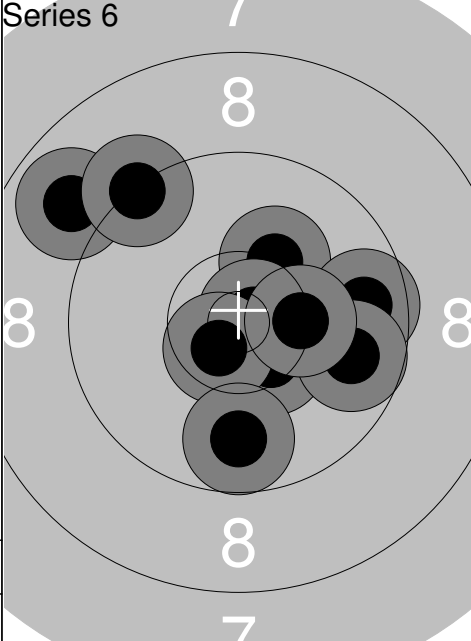
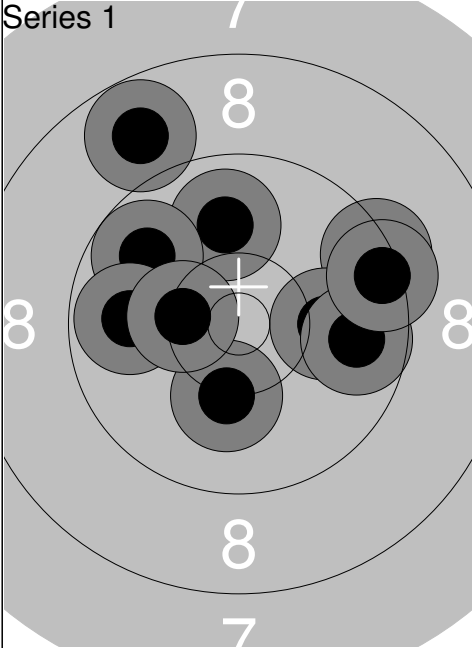
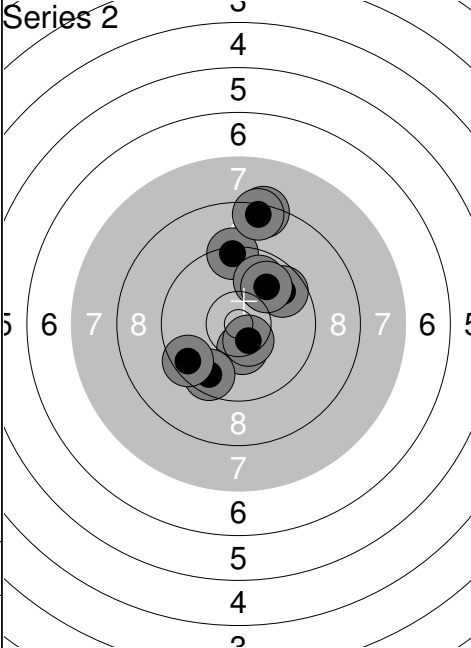
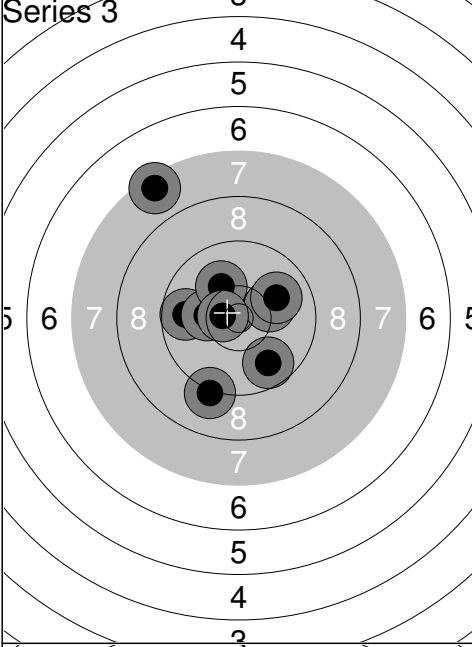
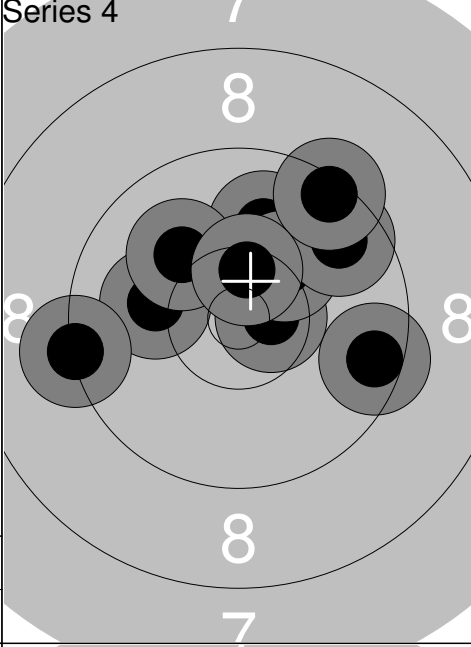
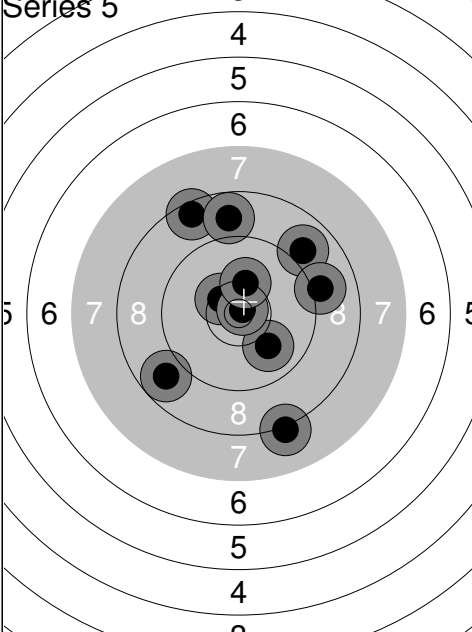
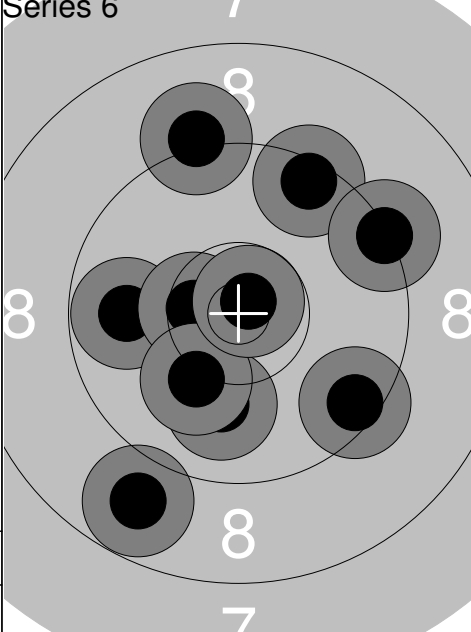

Relay	Lane	Arto JUSSILA			
JSM	VS-VA	APY			
10.03.2018	Joukkue SM	Kankaanpään Ampumaurheilijat			
Series 1		1: 9.9 ← 2: 9.8 ↘ 3: 8.7 ↓ 4: 8.3 ↓ 5: 8.1 ↓ 6: 9.5 ↓ 7: 9.6 → 8: 9.5 ↓ 9: 9.6 ↓ 10: 8.8 ←	Series 2		1: 8.5 ↘ 2: 8.2 ↘ 3: 10.2 → 4: 9.4 ↗ 5: 9.7 ← 6: 7.1 ↖ 7: 10.0 ↗ 8: 10.2 ↓ 9: 9.1 ↗ 10: 8.5 ↗
	Series	86	Series	88	
		86		174	
Series 3		1: 9.1 ↑ 2: 9.3 → 3: 8.9 ↓ 4: 10.1 ↖ 5: 9.3 ↓ 6: 8.8 ↗ 7: 8.4 ← 8: 8.9 ← 9: 10.4x ↑ 10: 9.9 ↗	Series 4		1: 10.6x ↖ 2: 10.0 ← 3: 9.5 → 4: 9.6 ↓ 5: 8.1 ↗ 6: 10.1 ↓ 7: 8.1 → 8: 8.8 ← 9: 10.1 ← 10: 10.7x ↘
	Series	88	Series	92	
		262		354	
Series 5		1: 10.0 ↘ 2: 10.1 ↖ 3: 9.9 ↗ 4: 8.8 ↓ 5: 9.7 ↖ 6: 8.5 ← 7: 9.4 ↖ 8: 7.8 ↑ 9: 10.4x ↘ 10: 9.2 ↘	Series 6		1: 10.2 ↓ 2: 9.4 ↑ 3: 9.3 ↑ 4: 9.9 ← 5: 9.7 ↗ 6: 10.4 ↑ 7: 9.2 → 8: 10.0 ↓ 9: 10.7x ↘ 10: 10.6x ↘
	Series	89	Series	95	
		443		538	

Relay	Lane	Marko TALVITIE	
1	22		
JSM	LehA	APY	
10.03.2018	Joukkue SM	Kankaanpään Ampumaurheilijat	
Series 1 	1:	9.1	↓
	2:	10.6x	↙
	3:	8.6	↖
	4:	10.2	→
	5:	10.0	↖
	6:	10.0	↑
	7:	6.9	↑
	8:	9.7	↙
	9:	8.1	↖
	10:	9.5	↙
Series	89		
Series 2 	1:	10.5x	→
	2:	7.9	↙
	3:	8.0	↙
	4:	9.0	↖
	5:	8.5	↗
	6:	8.3	↖
	7:	9.6	↖
	8:	10.3	↓
	9:	9.5	↘
	10:	9.1	↑
Series	87		
		176	
Series 3 	1:	10.0	↑
	2:	9.7	↓
	3:	9.7	→
	4:	10.8x	↙
	5:	10.6x	↘
	6:	10.0	↖
	7:	10.0	↖
	8:	9.5	↖
	9:	9.4	↗
	10:	9.7	↖
Series	95		
		271	
Series 4 	1:	9.8	↖
	2:	10.6x	↙
	3:	10.0	↑
	4:	8.1	↖
	5:	10.3	↑
	6:	9.2	↘
	7:	10.5x	↗
	8:	9.0	↘
	9:	10.6x	↘
	10:	9.8	↖
Series	94		
		365	
Series 5 	1:	10.0	↓
	2:	3.7	↖
	3:	9.8	↖
	4:	9.3	↗
	5:	9.3	→
	6:	9.0	↘
	7:	8.9	↘
	8:	6.7	↑
	9:	8.5	↖
	10:	10.4x	↘
Series	81		
		446	
Series 6 	1:	8.9	↖
	2:	10.2	↗
	3:	10.8x	↗
	4:	9.7	→
	5:	10.5x	↘
	6:	10.6x	↘
	7:	9.8	→
	8:	9.8	↓
	9:	10.3	→
	10:	9.3	↖
Series	94		
		540	

Relay <b>1</b>	Lane <b>23</b>	<b>Timo KIVELÄ</b>	
JSM	NoSA	APY	
10.03.2018	Joukkue SM	Kankaanpään Ampumaurheilijat	
Series 1		Series 2	
	1: 10.9x ↑ 2: 9.2 ↑ 3: 10.5x ↓ 4: 10.6x ↖ 5: 9.9 ↑ 6: 9.3 ↓ 7: 10.4x ↓ 8: 10.2 ↑ 9: 9.6 ← 10: 10.3 ↖ Series 96 96		1: 10.6x ↘ 2: 9.0 ↓ 3: 9.9 ← 4: 10.6x ← 5: 9.9 ↘ 6: 10.2 ↗ 7: 9.7 ↑ 8: 9.6 ↖ 9: 8.9 ↗ 10: 9.2 ↖ Series 92 188
Series 3		Series 4	
	1: 9.0 ↗ 2: 8.0 ↑ 3: 9.8 ↖ 4: 10.3 ← 5: 10.2 → 6: 9.0 ↑ 7: 7.8 ↑ 8: 9.1 ↖ 9: 8.8 ↖ 10: 10.0 ← Series 89 277		1: 10.6x ↘ 2: 9.6 ↓ 3: 10.1 ↗ 4: 9.9 ↑ 5: 9.1 → 6: 9.6 ↖ 7: 10.4x ↓ 8: 8.2 ↖ 9: 9.0 ↗ 10: 10.2 ↑ Series 93 370
Series 5		Series 6	
	1: 9.4 ↖ 2: 9.1 ↗ 3: 8.4 ↖ 4: 9.4 ↓ 5: 9.7 ← 6: 6.9 ↓ 7: 10.5x → 8: 9.2 ↗ 9: 8.3 ← 10: 9.9 ↑ Series 86 456		1: 9.7 ↗ 2: 9.7 ↑ 3: 9.4 ↗ 4: 8.0 ↗ 5: 10.4x → 6: 9.3 ← 7: 8.4 ↘ 8: 8.6 ← 9: 10.2 ↑ 10: 9.2 ↘ Series 89 545

Relay	Lane	Tomi LEMPIÄINEN		
1	24			
JSM	P-HA	APY		
10.03.2018	Joukkue SM	Kankaanpään Ampumaurheilijat		
	Series 1	1: 8.9 ↓	Series 2	1: 10.2 ↖
		2: 8.8 ↗		2: 8.1 →
		3: 9.5 ↘		3: 9.7 ↗
		4: 10.4x ↘		4: 10.1 ↘
		5: 10.0 ↘		5: 9.0 ↗
		6: 8.7 ↘		6: 10.3 ↘
		7: 9.8 ↘		7: 10.9x ↗
		8: 8.3 →		8: 10.4x ↘
		9: 9.6 ↘		9: 9.3 →
		10: 9.5 ↘		10: 10.1 ↘
		Series 88	Series 95	
	Series 3	1: 9.5 ↗	Series 4	1: 9.5 ↗
		2: 9.1 →		2: 8.6 →
		3: 10.1 ↓		3: 9.4 →
		4: 10.7x ↑		4: 10.0 ↓
		5: 9.8 ↘		5: 9.8 ↓
		6: 9.9 →		6: 8.9 →
		7: 10.0 ↓		7: 10.7x ↓
		8: 10.5x ↖		8: 10.1 ↓
		9: 10.0 →		9: 9.5 ↗
		10: 9.7 ↘		10: 9.6 ↘
		Series 95	Series 91	
	278			
	Series 5	1: 9.6 →	Series 6	1: 8.5 ↘
		2: 9.8 ↓		2: 8.7 ↖
		3: 9.8 ←		3: 10.4x →
		4: 9.1 ↖		4: 9.7 ↑
		5: 10.4x ↘		5: 9.8 ↓
		6: 10.3 ↗		6: 9.7 ↗
		7: 9.4 ↖		7: 9.4 ↖
		8: 10.8x ↖		8: 7.7 ↖
		9: 9.3 ↘		9: 9.4 ↓
		10: 9.2 ↗		10: 9.2 ←
		Series 93	Series 87	
	462			

Relay	Lane	Lauri LAUSTE		
1	25			
JSM	SA	APY		
10.03.2018	Joukkue SM	Kankaanpään Ampumaurheilijat		
Series 1		1: 10.2 ↓ 2: 9.9 ↑ 3: 9.4 ↗ 4: 10.1 → 5: 9.8 ↖ 6: 9.8 ← 7: 9.7 → 8: 9.4 → 9: 8.8 ↑ 10: 10.4x ←	Series 2 	1: 9.7 ↗ 2: 9.4 ↑ 3: 10.4x ↓ 4: 9.9 ↗ 5: 8.4 ↑ 6: 8.5 ↑ 7: 10.5x ↓ 8: 9.6 ↓ 9: 9.9 ↗ 10: 9.5 ↖
	Series 92	Series 90		
	92	182		
Series 3		1: 7.5 ↖ 2: 9.8 ← 3: 10.2 ← 4: 10.6x ↖ 5: 10.2 → 6: 10.1 ↗ 7: 10.0 → 8: 9.8 ↓ 9: 10.6x ← 10: 9.2 ↓	Series 4 	1: 10.1 ← 2: 10.0 ↑ 3: 9.5 → 4: 10.6x → 5: 10.2 ↗ 6: 9.7 ↗ 7: 9.4 ↗ 8: 9.3 ← 9: 10.1 ↖ 10: 10.5x ↑
	Series 94	Series 96		
	276	372		
Series 5		1: 10.4x ↖ 2: 8.8 ↖ 3: 8.5 ↗ 4: 8.1 ↓ 5: 8.9 ↗ 6: 9.0 → 7: 10.0 ↓ 8: 8.8 ↑ 9: 10.8x ↗ 10: 10.3 ↑	Series 6 	1: 9.1 ↑ 2: 8.8 ↓ 3: 9.8 ← 4: 10.0 ↓ 5: 9.4 ↗ 6: 9.3 ↗ 7: 9.5 ↘ 8: 10.5x ← 9: 10.2 ↓ 10: 10.8x ↗
	Series 89	Series 93		
	461	554		

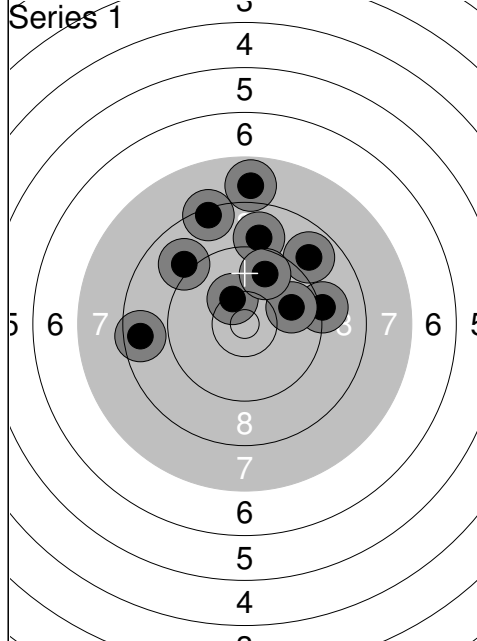

1:	10.3	↗
2:	9.2	→
3:	9.0	↑
4:	8.9	↗
5:	9.8	→
6:	9.0	↖
7:	7.9	↑
8:	8.4	↑
9:	8.6	←
10:	9.7	↑
<b>Series</b>	<b>86</b>	
	<b>86</b>	

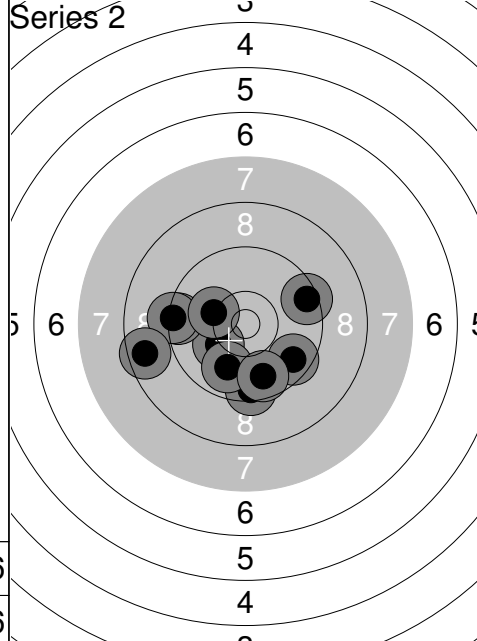

1:	10.2	↖
2:	9.4	←
3:	9.5	↓
4:	9.6	↘
5:	9.3	←
6:	8.6	←
7:	9.9	↓
8:	9.5	→
9:	10.2	←
10:	9.7	↓
<b>Series</b>	<b>91</b>	
	<b>177</b>	

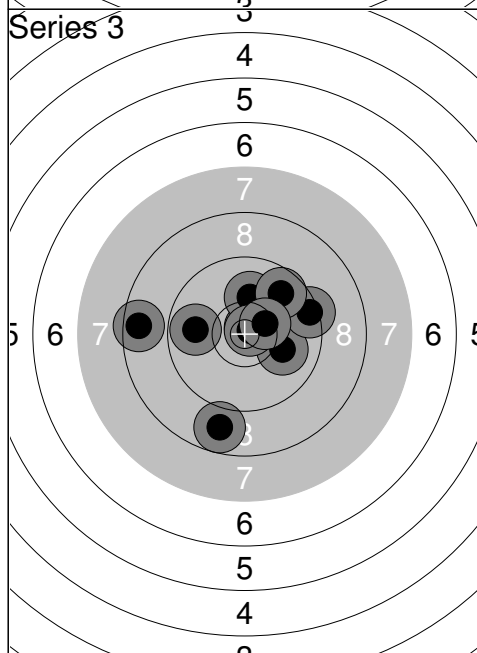

1:	10.0	→
2:	8.6	←
3:	10.7x	↗
4:	9.4	→
5:	10.1	↑
6:	8.8	↓
7:	10.8x	↗
8:	9.8	←
9:	9.7	↗
10:	10.4x	↗
<b>Series</b>	<b>93</b>	
	<b>270</b>	

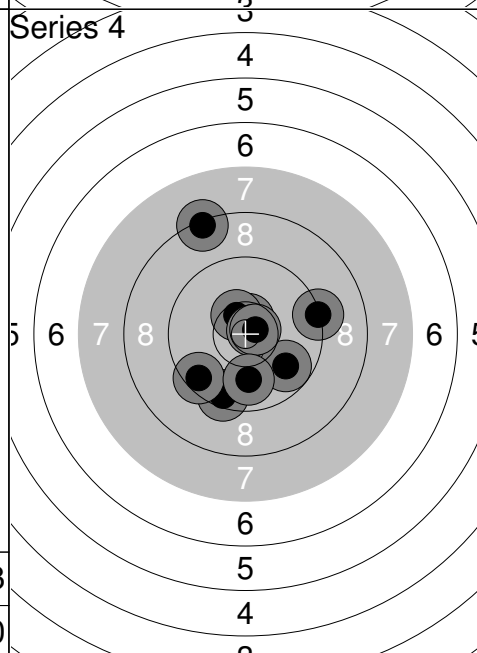

1:	10.6x	↑
2:	9.3	→
3:	10.5x	↖
4:	9.5	↓
5:	10.8x	↗
6:	9.8	↘
7:	10.7x	↗
8:	9.5	↖
9:	8.3	↑
10:	9.9	↓
<b>Series</b>	<b>93</b>	
	<b>363</b>	

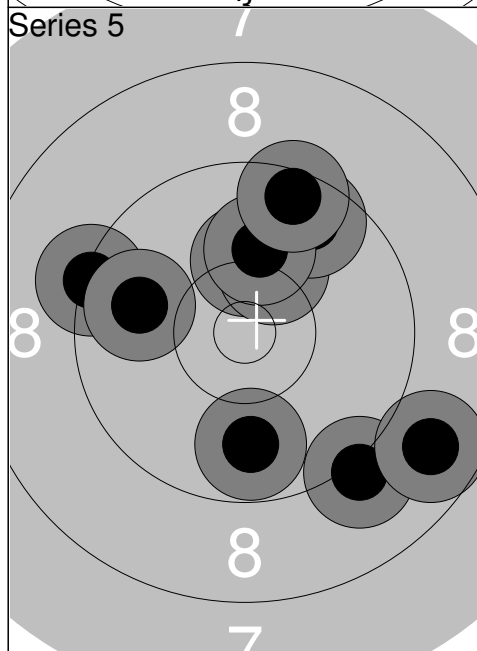

1:	10.2	↑
2:	9.8	↓
3:	10.2	↗
4:	9.1	↘
5:	9.3	←
6:	8.7	↘
7:	9.8	←
8:	9.6	↗
9:	10.1	↑
10:	9.5	↑
<b>Series</b>	<b>92</b>	
	<b>455</b>	

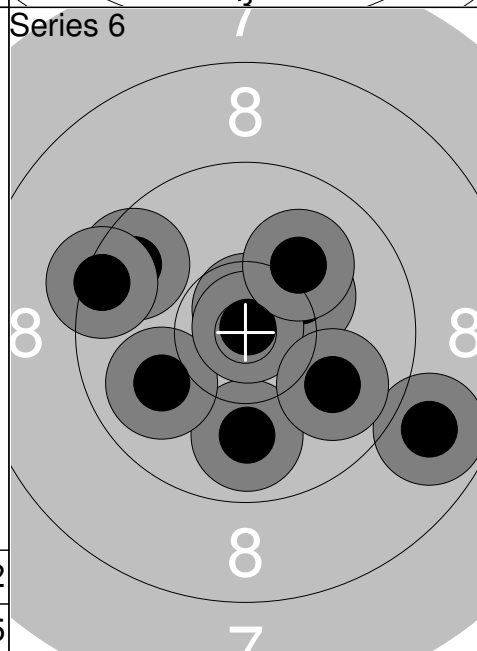

1:	9.6	↖
2:	8.8	↘
3:	10.3	↗
4:	10.7x	↑
5:	9.4	←
6:	9.9	↓
7:	9.9	↖
8:	10.9x	↗
9:	10.1	↗
10:	9.9	↘
<b>Series</b>	<b>93</b>	
	<b>548</b>	

Relay	Lane	Jarmo SALO	
1	27	JSM	LSA
10.03.2018	Joukkue SM	Kankaanpään Ampumaurheilijat	
Series 1		1: 8.4 ← 2: 10.0 ← 3: 9.9 ↓ 4: 10.1 ↑ 5: 9.1 ↗ 6: 10.6x ↑ 7: 10.2 → 8: 10.1 ↓ 9: 10.1 ↑ 10: 10.3 →	Series 2
		Series	96
			96
Series 2		1: 10.2 → 2: 9.0 ← 3: 10.3 → 4: 9.6 → 5: 9.9 ↗ 6: 9.8 → 7: 10.3 ← 8: 10.8x ↗ 9: 9.2 ↓ 10: 10.9x ↗	Series
		Series	95
			191
Series 3		1: 8.7 → 2: 10.0 ← 3: 10.2 ↑ 4: 10.8x ↗ 5: 9.3 ↗ 6: 10.1 ↓ 7: 9.4 ↓ 8: 9.7 ← 9: 8.7 ← 10: 10.0 ↗	Series 4
		Series	93
			284
Series 4		1: 10.6x ← 2: 10.4x ← 3: 9.1 → 4: 10.9x → 5: 10.1 ↑ 6: 10.1 ← 7: 9.6 ← 8: 9.7 ↗ 9: 8.9 ↗ 10: 9.6 →	Series
		Series	94
			378
Series 5		1: 8.5 → 2: 9.6 ↑ 3: 10.0 → 4: 9.1 ↗ 5: 9.8 ← 6: 9.3 ← 7: 8.9 → 8: 9.3 ↓ 9: 8.7 ↗ 10: 9.9 ↑	Series 6
		Series	88
			466
Series 6		1: 9.8 → 2: 10.1 ↓ 3: 10.7x ↓ 4: 9.7 ↗ 5: 8.5 ↓ 6: 8.5 → 7: 10.2 ← 8: 9.8 ↗ 9: 10.5x ↑ 10: 10.4x ↓	Series
		Series	93
			559

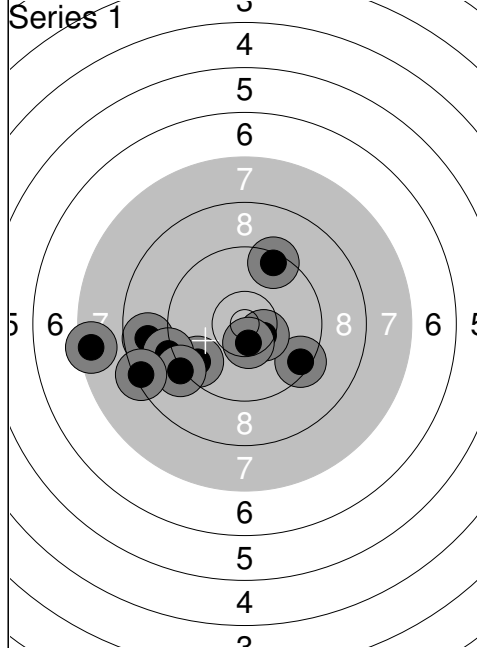

1:	9.4	↗
2:	8.8	←
3:	9.6	↙
4:	9.4	↘
5:	10.5x	↘
6:	9.1	←
7:	9.2	↙
8:	7.5	←
9:	10.5x	↘
10:	8.4	←
<b>Series</b>	<b>88</b>	
	<b>88</b>	

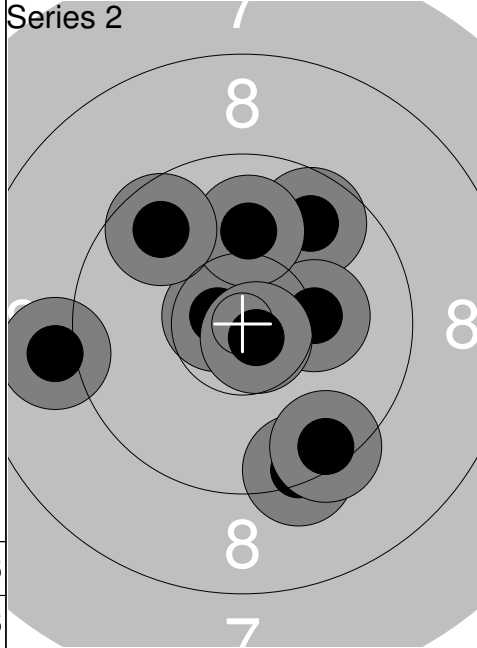

1:	9.4	↘
2:	10.4x	↗
3:	9.7	↗
4:	9.4	↘
5:	10.2	→
6:	10.7x	↙
7:	10.0	↑
8:	9.0	←
9:	9.7	↗
10:	10.8x	↘
<b>Series</b>	<b>95</b>	
	<b>183</b>	

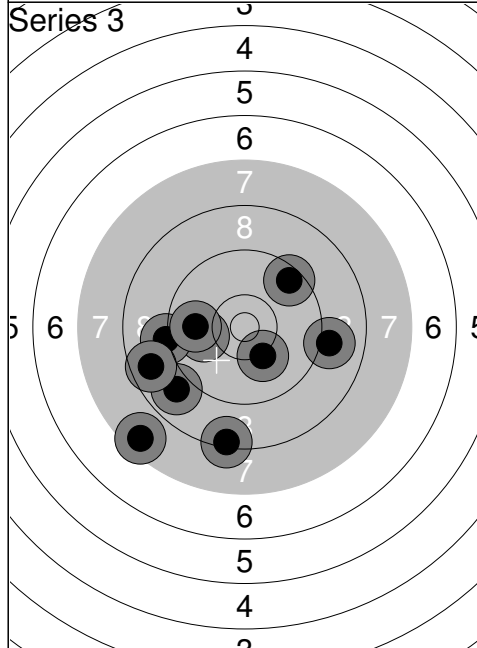

1:	10.0	←
2:	9.2	←
3:	9.5	↗
4:	9.0	→
5:	8.3	↘
6:	8.9	↙
7:	7.5	↙
8:	8.7	←
9:	9.9	←
10:	10.2	↘
<b>Series</b>	<b>87</b>	
	<b>270</b>	

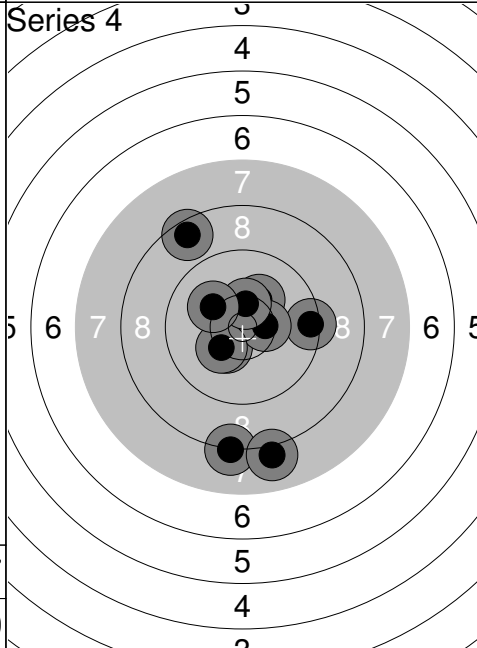

1:	8.2	↘
2:	8.0	↘
3:	9.4	→
4:	10.4x	↙
5:	10.2	↗
6:	10.4x	→
7:	10.3	↙
8:	10.4x	↑
9:	8.6	↗
10:	10.1	↙
<b>Series</b>	<b>93</b>	
	<b>363</b>	

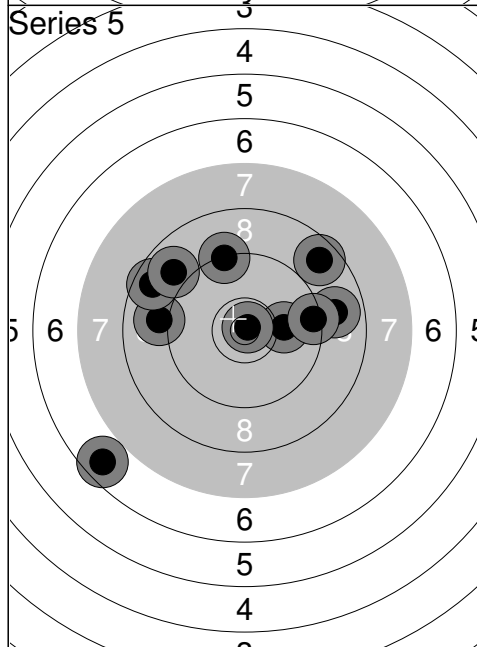

1:	9.0	←
2:	8.9	→
3:	6.6	↙
4:	10.1	→
5:	8.7	↙
6:	9.4	→
7:	10.9x	↗
8:	8.9	↙
9:	9.3	↑
10:	8.6	↗
<b>Series</b>	<b>85</b>	
	<b>448</b>	

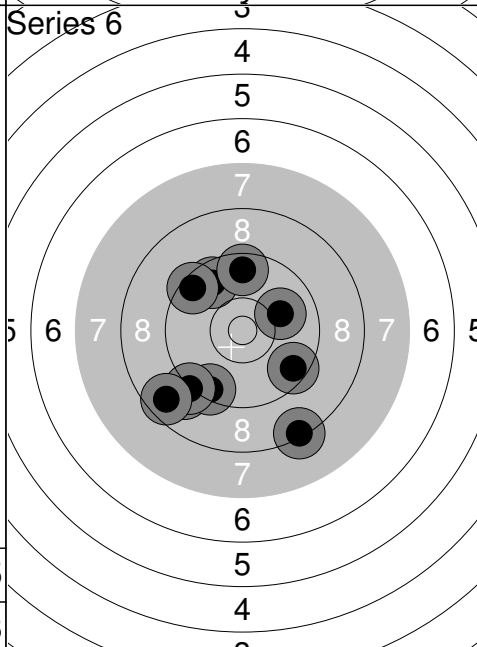

1:	9.7	↗
2:	9.0	↙
3:	10.0	→
4:	9.5	↙
5:	9.4	↘
6:	9.5	↘
7:	9.2	↙
8:	9.6	↑
9:	8.7	↙
10:	8.3	↘
<b>Series</b>	<b>89</b>	
	<b>537</b>	

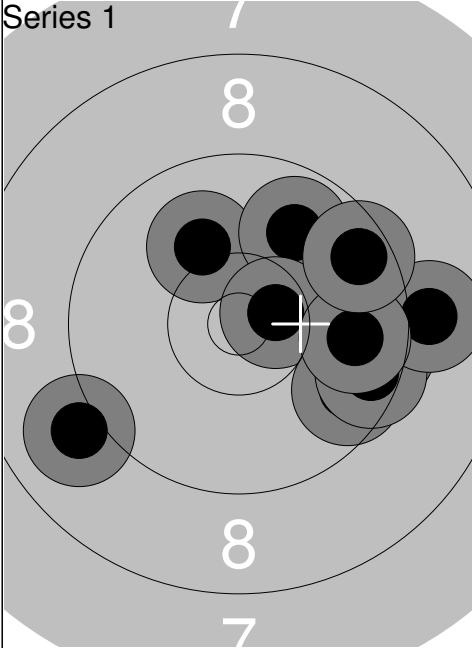
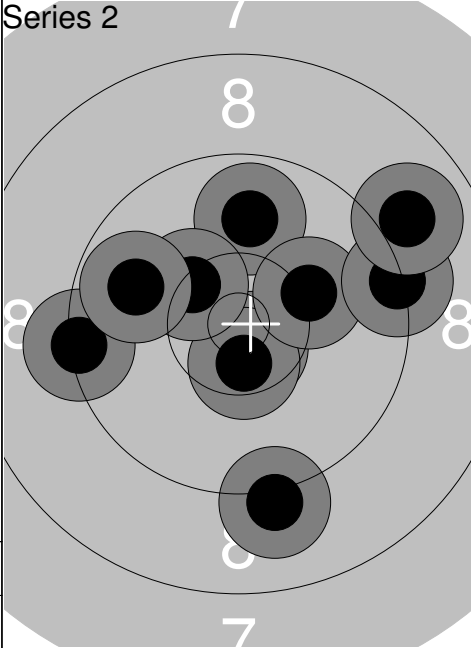
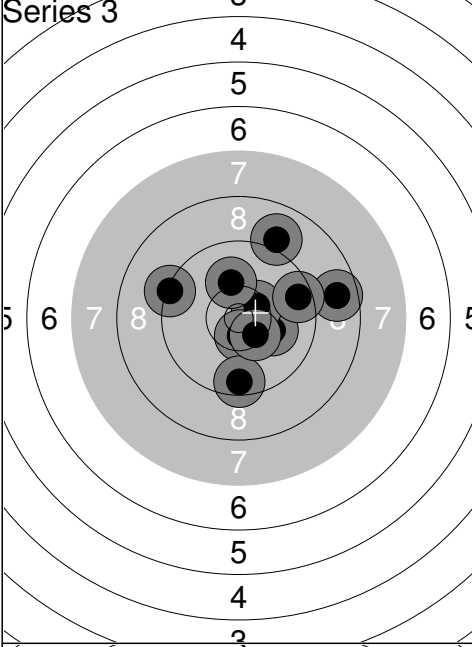
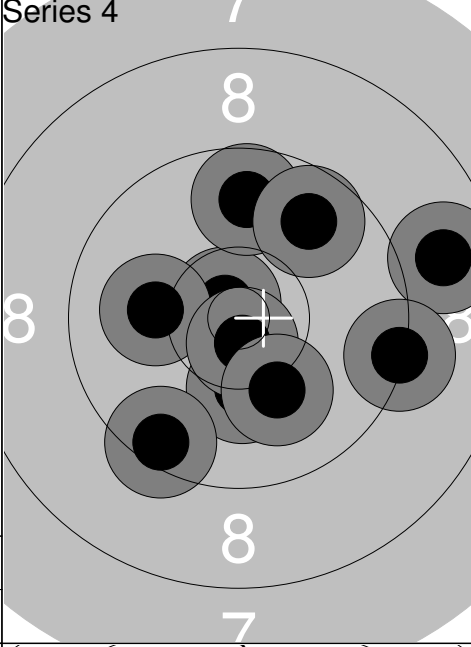
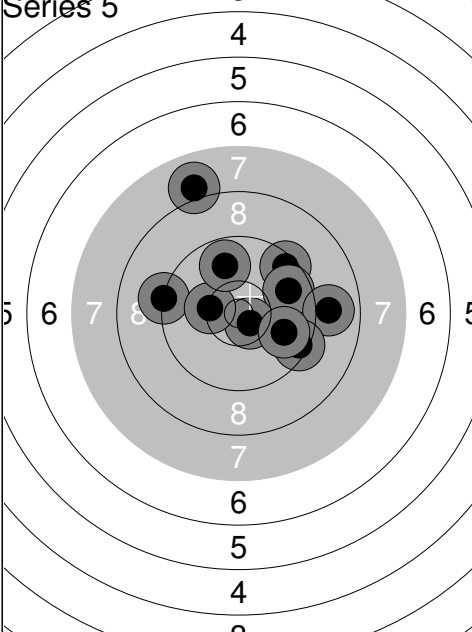
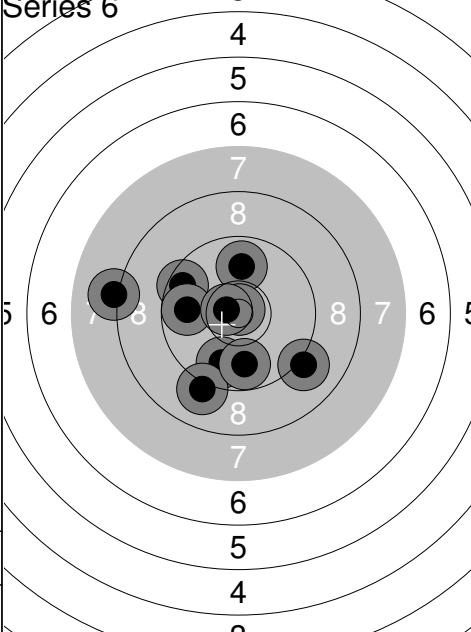

Relay	Lane	Susanna AHOMÄKI	
1	29		
JSM	HSA	APY	
10.03.2018	Joukkue SM	Kankaanpään Ampumaurheilijat	
Series 1		1: 9.0 ↙ 2: 10.1 ↗ 3: 9.9 ↗ 4: 10.5x → 5: 9.5 → 6: 9.7 ↘ 7: 9.5 → 8: 9.0 → 9: 9.8 → 10: 9.6 ↗	Series 92 92
Series 2		1: 9.3 ← 2: 9.9 ↑ 3: 9.1 ↓ 4: 10.7x ↘ 5: 10.5x ↘ 6: 10.3 ↗ 7: 9.8 ← 8: 10.2 → 9: 9.3 → 10: 8.9 ↗	Series 93 185
Series 3		1: 8.7 → 2: 9.3 ← 3: 10.1 → 4: 10.5x ↗ 5: 10.5x ↘ 6: 9.5 ↘ 7: 10.4x ↘ 8: 10.1 ↑ 9: 9.0 ↗ 10: 9.5 →	Series 94 279
Series 4		1: 10.7x ↖ 2: 10.1 ← 3: 9.7 ↑ 4: 9.7 ↗ 5: 10.2 ↓ 6: 10.7x ↘ 7: 9.5 ↘ 8: 8.8 → 9: 9.3 → 10: 10.1 ↘	Series 94 373
Series 5		1: 9.5 ↗ 2: 9.7 → 3: 10.6x ↘ 4: 9.2 ← 5: 8.9 → 6: 9.4 ↘ 7: 10.3 ← 8: 9.8 ↑ 9: 9.8 → 10: 8.0 ↑	Series 90 463
Series 6		1: 9.5 ← 2: 9.8 ↘ 3: 9.1 ↘ 4: 9.1 ↘ 5: 9.8 ↘ 6: 9.9 ↑ 7: 10.9x ↑ 8: 8.1 ← 9: 9.8 ← 10: 10.7x ←	Series 91 554

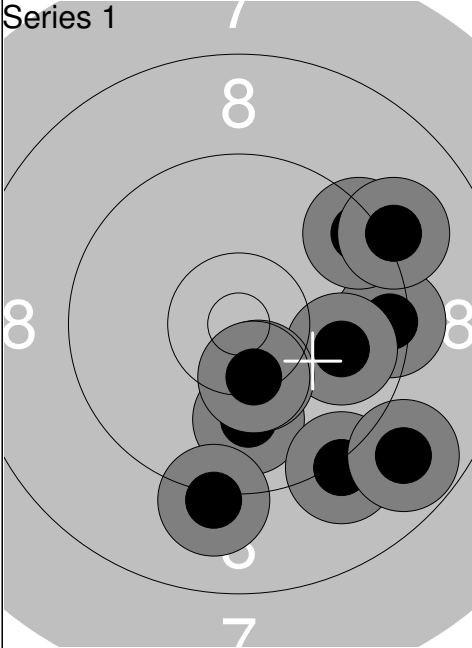
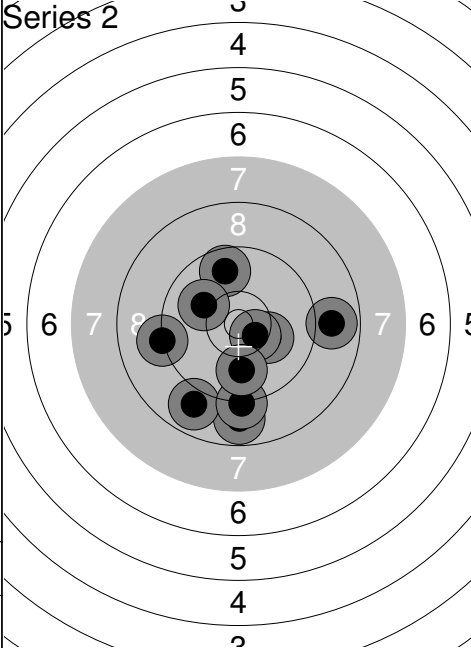
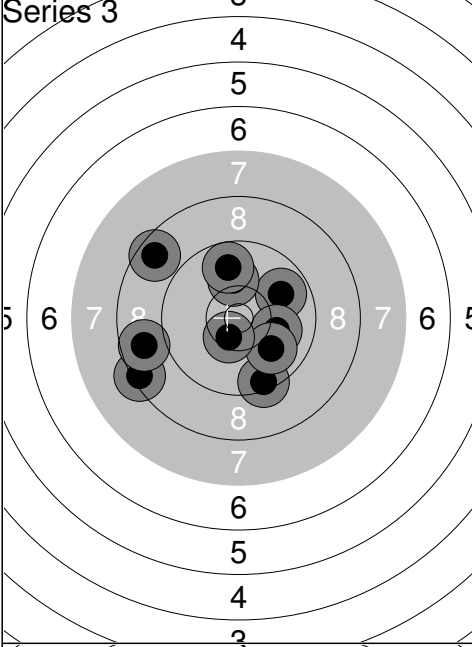
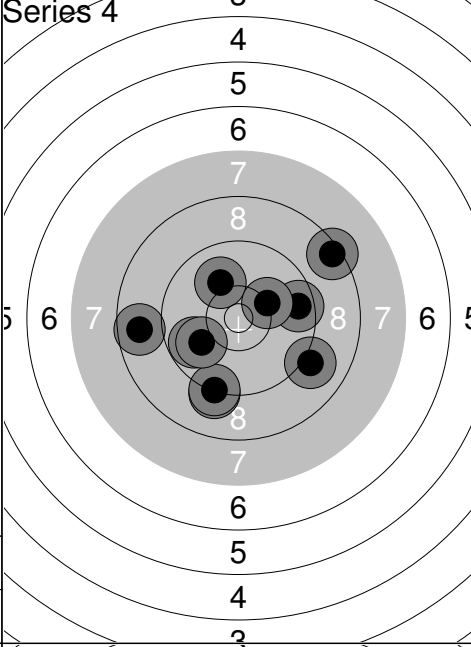
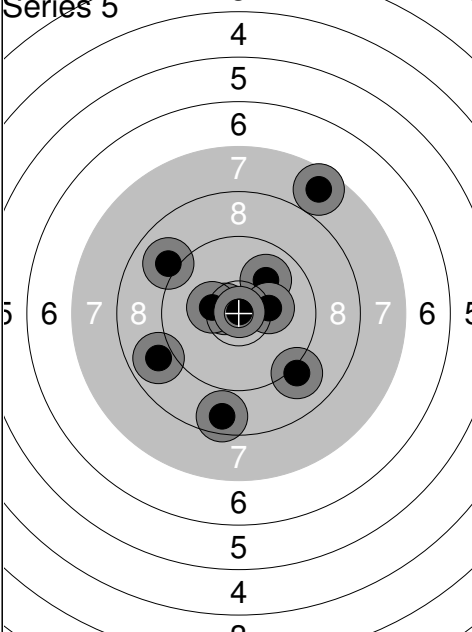
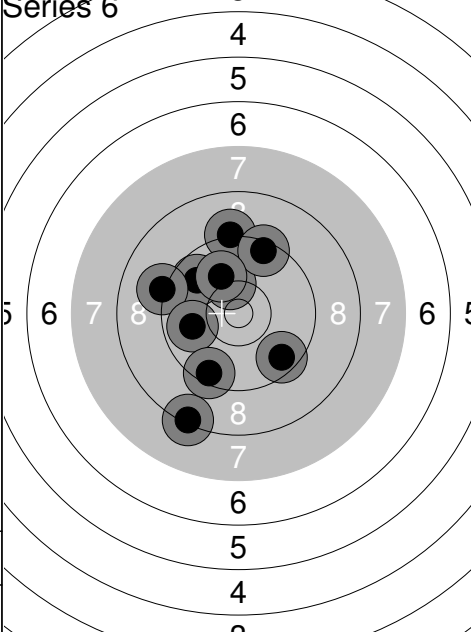
Relay <b>1</b>	Lane <b>30</b>	<b>Elina SILVER</b>			
JSM	TSA	APY			
10.03.2018	Joukkue SM	Kankaanpään Ampumaurheilijat			
Series 1		1: 10.0 ↓ 2: 9.4 → 3: 9.2 ↓ 4: 9.1 ↓ 5: 9.9 → 6: 10.4x ↓ 7: 10.4x ↓ 8: 8.8 ↓ 9: 9.4 ↗ 10: 9.1 ↗ Series 92 92	Series 2		1: 9.2 ← 2: 9.7 ↑ 3: 8.8 ↓ 4: 8.9 ↓ 5: 9.2 ↓ 6: 10.2 → 7: 10.1 ↖ 8: 10.5x ↘ 9: 8.9 → 10: 9.9 ↓ Series 90 182
Series 3		1: 8.4 ← 2: 9.9 ↗ 3: 10.1 ↑ 4: 10.1 → 5: 9.4 ↓ 6: 10.0 ↓ 7: 10.5x ↓ 8: 9.8 ↑ 9: 8.6 ↖ 10: 8.7 ← Series 91 273	Series 4		1: 9.8 ← 2: 8.7 ← 3: 8.4 ↗ 4: 9.1 ↘ 5: 10.1 ↗ 6: 9.2 ↓ 7: 9.3 ↓ 8: 9.6 → 9: 10.2 ↗ 10: 10.0 ↖ Series 91 364
Series 5		1: 7.7 ↗ 2: 10.0 ↗ 3: 10.3 → 4: 10.6x ← 5: 8.9 ← 6: 10.3 ← 7: 10.9x ↗ 8: 8.6 ↓ 9: 9.1 ↓ 10: 9.0 ↖ Series 91 455	Series 6		1: 10.2 ↑ 2: 9.8 ↖ 3: 9.2 ← 4: 8.3 ↓ 5: 9.9 ← 6: 9.2 ↑ 7: 9.4 ↗ 8: 9.5 ↓ 9: 9.6 ↘ 10: 10.0 ↗ Series 91 546